



563 kW (Tier IV)



708 kW (Tier II, Tier IV)



140 t



63,5 m



6140E

Heavy Duty Cycle Crawler Crane

Tier IV emission standards

6140E Advanced. The E-Series



What makes up the E-Series

- Over 65 years of experience in the design and construction of duty cycle cranes
- Uncompromisingly high performance in all areas
- Technology that can be mastered: High-quality components without over-engineering
- Long service life and high value stability

1969: First full hydraulic duty cycle crawler crane worldwide, SK 15

Your top benefits:

1 Green Efficiency

Save fuel – reduce operating costs
Work quietly – protect operator and environment



2 Peak performance

Durable mechanical systems – stressed parts optimized
High speeds – high load capacities

3 Maximum usability

Maxcab – work in comfort
SENCON – work program selection made easy



4 Flexibility in service

Use in special civil engineering with various accessory equipment
Strong undercarriage traction – good all-terrain mobility

5 Easy transport

Broad gauge undercarriage with removable traveling gear – ready to go in no time
Ballast support system – short set-up time

6 Maintenance and service made easy

SENNEBOGEN control system – easy error diagnostics
Simple maintenance – clear labeling

7 Consultation and support in your area

3 production sites – 2 subsidiaries
130 sales partners – over 350 service stations



6140E *Technical data, equipment*

MACHINE TYPE

Model (type) **6140**

ENGINE

Power **CAT C18 563 kW / 766 PS at 1800 min⁻¹ (TIER IV)**
CAT C27 708 kW / 963 PS at 1800 min⁻¹ (TIER II/TIER IV)

Direct injection, turbo-charged, charge air cooling, idle / automatic stop

Cooling Water-cooled

Air filter Dry filter with pre-separator, automatic dust discharge, main element and safety element, contamination indicator

Fuel tank **940 l**

Electr. system **24 V**

Batteries **2 x 150 Ah**, main switch

UPPERCARRIAGE

Design Torsion-resistant box design, precision crafted, bronze bushings for boom bearing arrangement
 clear and very service-friendly concept engine installed in the longitudinal direction

Lighting LED headlights for optimal illumination of the work area

Safety Camera monitoring of the rear area and right side
 Ballast filling equipment, walkways left and right of the uppercarriage

Options

- Low-temperature package for use at temperatures below -20 °C
- Pinion tooth lubrication for slewing ring
- Automatic central lubrication system for equipment and slewing ring, inner
- Maritime climate varnishing as corrosion protection
- Gallery left/right
- Increased rear ballast 45 t instead of 34 t

HYDRAULIC SYSTEM

Multi-circuit hydraulic system for optimal function and capacity, all movements can be run simultaneously. The hydraulic pumps are variable displacement piston pumps with individual control and energy-saving flow-on-demand control. The pumps only supply as much oil as is actually consumed. Pressure cut-off, load limit sensing control

Operating pressure	max. 330 bar
Filtration	High-performance filtration with long-term change interval, contamination level indicator
Hydraulic tank	1200 l (1000 l to the middle of the sight glass)
Control system	Proportional, precision hydraulic servo control of the movements, 2 servo joysticks for work functions, supplemental functions via switches and foot pedals – arranged clearly and ergonomically
Options	<ul style="list-style-type: none"> ■ Organic oil filling ■ SENNEBOGEN HydroClean 3 µm hydraulic microfilter ■ Potentiometer for casing machine and other attachments ■ Grapple fill automation ■ Supplemental hydraulic system with 1 x 440 l/min

SLEWING DRIVE

Gearbox	2x compact planetary gears with slant axis hydraulic motor, integrated brake valves, precision slewing gear brake
Parking brake	Spring-loaded multi-disk brake
Slewing ring	Three-row roller bearing rotary connection with exterior gearing
Slewing speed	0-3,4 min ⁻¹ , 3 adjustable rotation speeds

CAB

Cab type	Maxcab rigid
Cab equipment	Sliding door, excellent ergonomics, climate automation, seat heater, air-suspension comfort seat, fresh air filter / circulating air filter, joystick steering, 12 V / 24 V USB connections, SENCON, roof window, sliding windows on the driver's side
Options	<ul style="list-style-type: none"> ■ Cab type E270, can be elevated 270 cm ■ Cab can be tilted 15° ■ Auxiliary heating system with timer ■ Cabs with active carbon filter inside/outside air ■ Armored-glass windshield ■ Armored-glass sunroof ■ Safety side window and rear window ■ Sunblind for windshield ■ Protective roof grating ■ FOPS protective roof grating ■ Protective front grating ■ Radio with speakers ■ electrical cooler

6140E *Technical data, equipment*

ATTACHMENTS

Design	Decades of experience and the latest computer simulations guarantee the greatest degree of stability and longest service life
Boom adjustment winch	Drive via slant axis hydraulic motor with compact planetary gear, pulling force 110 kN, rope diameter 20 mm, adjustment speed 15° to 83° in approx. 90 seconds.
Safety brake	Spring-loaded multi-disk brake
Boom	Boom length to 63.5 m
Options	<ul style="list-style-type: none"> ■ Auxiliary jib, for load ratings to 24 t ■ Fly jib up to 29.9 m ■ Load moment limitation for hoisting implementation: latest generation of load moment monitoring, display shows all important data, lifting limit switch, pressure relief valves, rope run-out safeguard

UNDERCARRIAGE

Design	Very strong broad gauge undercarriage type R140/550 with selectable track width between 4.60 m and 5.50 m, stable welded construction
Drive	Strong travel drive with axial piston hydraulic motor and directly attached automatically functioning brake valve and compact planetary gear on each running gear side; protected drive transmission
Parking brake	Spring-loaded multi-disk brake
Traveling gear	Maintenance-free tractor traveling gear B9HDS with hydraulic chain tension, 1000 mm flat base plates
Speed	0 - 1.6 km/h

WINCH

The winches are driven via high-pressure-regulated adjustable hydraulic motors, thus there is always optimal pulling force speed control. Hydraulic lowering brake valves for sensitive, wear-free braking. Strong oil-bath planetary gear, low-maintenance.

Crane and free fall brakes are spring-loaded, maintenance-free, low-wear disc brakes running in the oil bath, oil-cooled. The driver is assisted by the special, continuously-variable free fall brake that also helps to protect the machine.

	25 t	30 t	35 t
Rope winch (rated load) 1st layer	250 kN	300 kN	350 kN
Rope diameter	34 mm	36 mm	36 mm
Rope speed 2nd layer	0-98 m/min	0-98 m/min	0-87 m/min
Rope speed capacity 1st layer	48.7 m	56.7 m	61.4 m

Options	<ul style="list-style-type: none"> ■ Grapple steadying winch 30 kN ■ Rope tensioning pulley ■ Depth indicating device
---------	--

OPERATING WEIGHT

Mass **approx. 126 t**

6140 R with 2 x 25 t freefall winches, basic boom 13.1 m, counterweight 34 t, 60 t bottom hook block, 1000 mm flat base plates, 150 m hoisting rope

Notice The operating weight varies depending on the version and equipment.

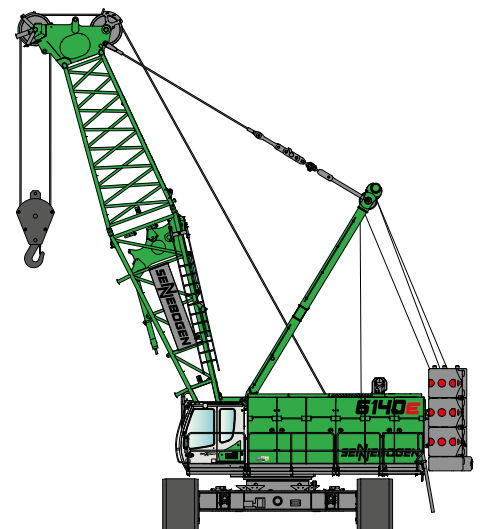

6140E Crane equipment



Main boom

Auxiliary jib SH
max. working load 24 t

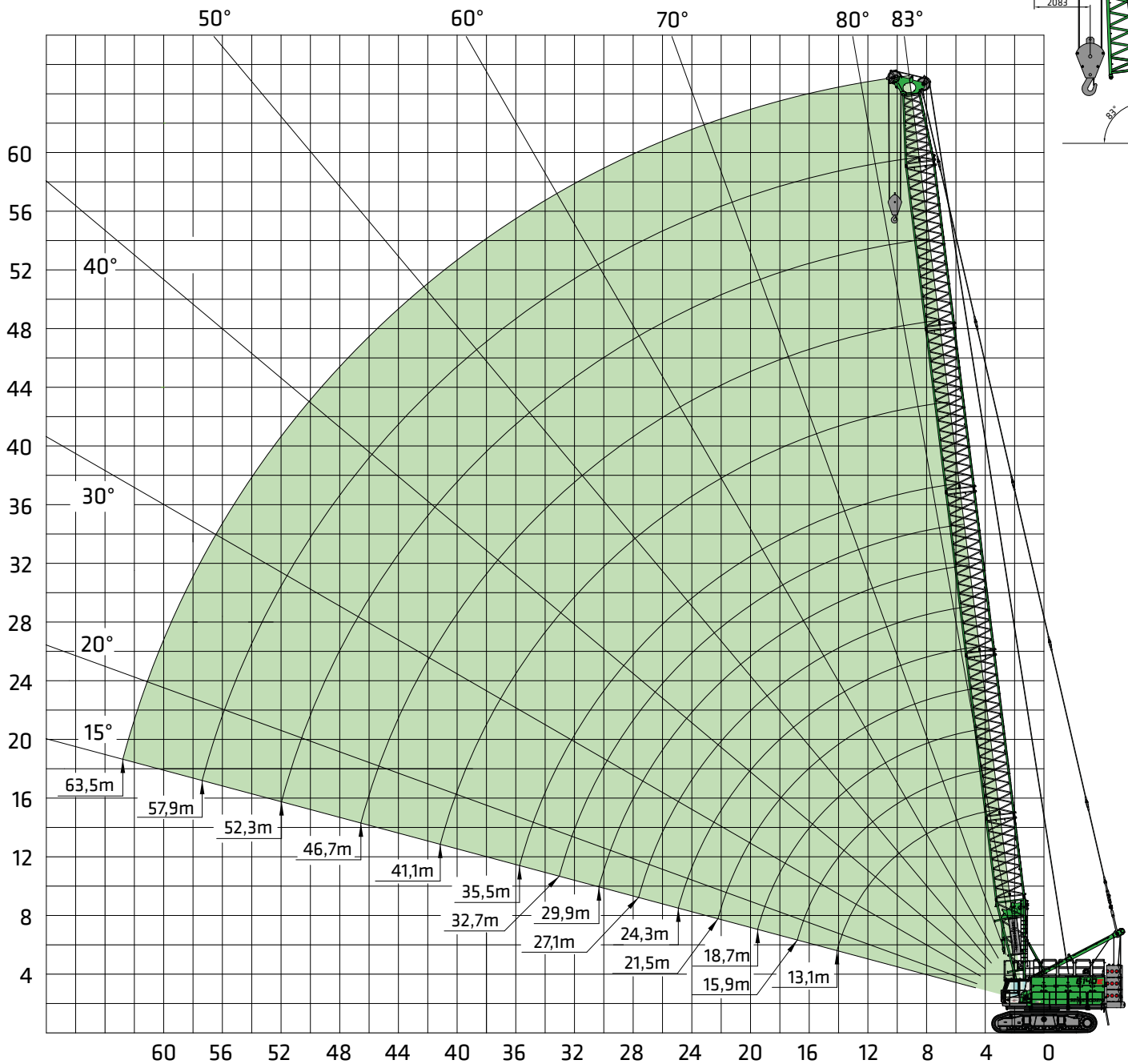
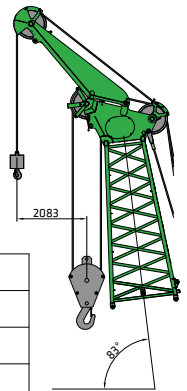

Boom configuration

Boom length [m]

		13.1	15.9	18.7	21.5	24.3	27.1	29.9	32.7	35.5	41.1	46.7	52.3	57.9	63.5
Lower boom section type 2008	7 m	1	1	1	1	1	1	1	1	1	1	1	1	1	1
Boom section type 2008	2.8 m	0	1	0	1	0	1	0	1	0	0	0	0	0	0
Boom section type 2008	5.6 m	0	0	1	1	2	2	1	1	2	1	2	1	2	1
Boom section type 2008	11.2 m	0	0	0	0	0	0	1	1	1	2	2	3	3	4
Head piece type 2008	6.1 m	1	1	1	1	1	1	1	1	1	1	1	1	1	1
Auxiliary jib S24.1 (option)	24.0 t	x	x	x	x	x	x	x	x	x	x	x	x	x	x

6140E Load capacity



Main boom

Undercarriage track width 5500 mm

45 t outreach [m]	Boom length [m]													
	13.1	15.9	18.7	21.5	24.3	27.1	29.9	32.7	35.5	41.1	46.7	52.3	57.9	63.5
4.0	140.0	124.8/8.4	122.5/4.7											
5.0	136.9	123.0	121.6	114.0	101.7/5.4	95.4/5.7								
6.0	116.2	116.0	115.8	111.7	100.5	94.9	84.0	77.8/6.4	70.0/6.8					
7.0	99.2	99.0	98.8	98.5	95.0	92.0	82.6	77.0	69.6	58.1/7.4				
8.0	86.4	86.2	86.0	84.0	81.0	78.7	76.0	73.5	68.4	57.7	50.7/8.1	41.9/8.8		
9.0	72.4	72.2	72.1	71.9	70.8	68.5	66.5	64.5	62.8	57.1	50.1	41.7	34.7/9.5	
10.0	61.8	61.6	61.5	61.2	61.2	60.8	59.0	57.5	56.0	53.2	49.4	40.8	34.3	28.9/10.2
11.0	53.8	53.6	53.5	53.2	53.1	52.9	52.8	51.7	50.4	48.0	45.7	39.9	33.5	28.3
12.0	47.6	47.4	47.2	47.0	46.9	46.6	46.6	46.4	45.7	43.7	41.6	39.0	32.6	27.6
13.0	42.6	42.3	42.2	41.9	41.8	41.6	41.5	41.3	41.3	40.0	38.1	36.4	31.8	26.9
14.0	35.6	38.2	38.1	37.8	37.7	37.4	37.4	37.2	37.2	36.8	35.1	33.6	31.0	26.2
15.0	30.0/14.4	34.8	34.6	34.4	34.3	34.0	33.9	33.7	33.7	33.3	32.5	31.1	29.7	25.4
16.0		31.9	31.7	31.5	31.3	31.1	31.0	30.8	30.8	30.4	29.9	28.9	27.6	24.7
17.0		26.5	29.3	29.0	28.8	28.6	28.5	28.2	28.2	27.8	27.4	27.0	25.7	24.0
18.0		26.5/17.1	27.1	26.8	26.7	26.4	26.3	26.1	26.0	25.6	25.2	24.8	24.0	23.0
19.0			25.3	24.9	24.8	24.5	24.4	24.1	24.1	23.7	23.2	22.9	22.6	21.5
20.0			24.0/19.8	23.3	23.1	22.8	22.7	22.5	22.4	22.0	21.5	21.2	20.9	20.2
22.0				20.5	20.3	20.0	19.9	19.6	19.6	19.2	18.7	18.3	18.0	17.6
24.0				20.0/22.5	18.1	17.7	17.6	17.3	17.3	16.8	16.4	16.0	15.7	15.3
26.0					17.0/25.1	15.9	15.7	15.4	15.4	14.9	14.4	14.1	13.8	13.3
28.0						14.5/27.9	14.2	13.9	13.8	13.3	12.8	12.5	12.1	11.7
30.0							12.9	12.6	12.4	12.0	11.5	11.1	10.8	10.3
32.0							12.6/30.6	11.4	11.3	10.8	10.3	9.9	9.6	9.1
34.0								10.8/33.3	10.3	9.8	9.3	8.9	8.5	8.1
36.0									9.4	8.9	8.4	8.0	7.6	7.2
38.0										8.1	7.6	7.2	6.8	6.4
40.0											7.5	6.9	6.5	6.1
42.0											7.1/41.4	6.3	5.9	5.5
44.0												5.8	5.3	4.9
46.0												5.3	4.8	4.4
48.0												5.1/46.8	4.4	3.9
50.0													4.0	3.5
52.0													3.6	3.1
54.0													3.6/52.2	2.8
56.0														2.5
58.0														2.2/57.6
60.0														1.4
62.0														1.2
64.0														1.1/63.0
ø [mm]	Number of strands													
36	6	6	6	5	5	4	4	4	3	3	3	2	2	2
34	8	7	7	6	6	5	5	4	4	3	3	3	2	2

Table no. 6140 R-80/2838/45.0/11.16 SH

Notes:*

- The specified safe working load values apply to ensure level and firm standing of the machine.
- The safe working load values are specified in tons (t) and apply for 360 degrees.
- The safe working loads take the standards ISO 4305 Tab. 1+2 and the tilt angle method (tilt angle 4°) into account
- Deduct the weight of the load handling devices (hook, suspension gear) from the safe working loads.
- The safe working load values apply for the maximum undercarriage track width of 4600/5500 mm.
- Load ratings must be limited or reduced to take into account unfavorable conditions, such as soft or uneven ground, slopes, wind, lateral loads, swinging loads, jerking or sudden stopping of the load, operator inexperience, driving with load.
- Permissible rope tension per strand in crane operation for rope diameter with 36 mm - 24,000 kg / with rope diameter 34 mm - 20,000 kg
- Safe working load values apply for the SH boom (boom assembly in accordance with the operating manual).
- Load ratings apply to optimum boom assembly and a pulley head with steel cable pulleys.
- The specified safe working load values are only for orientation. See the operating manual for the respectively valid safe working loads.

6140E Load capacity



Main boom

Undercarriage track width 5500 mm

34.0 t outreach [m]	Boom length [m]												
	13.1	15.9	18.7	21.5	24.3	27.1	29.9	32.7	35.5	41.1	46.7	52.3	57.9
4.0	140.0	124.8/8.4	122.5/4.7										
5.0	131.0	123.0	121.6	114.0	101.7/5.4	95.4/5.7							
6.0	108.6	108.4	107.7	102.8	98.5	94.0	84.0	77.8/6.4	70.0/6.8				
7.0	92.7	91.8	88.1	84.8	81.6	78.5	75.8	73.2	69.6	58.1/7.4			
8.0	74.4	74.2	74.1	71.9	69.5	67.2	65.1	63.0	61.1	57.5	50.7/8.1	41.9/8.8	
9.0	61.8	61.6	61.5	61.4	60.4	58.6	57.0	55.2	53.6	50.8	48.0	41.7	34.7/9.5
10.0	52.7	52.5	52.3	52.2	52.0	51.8	50.5	49.0	47.7	45.3	42.9	40.8	34.3
11.0	45.8	45.6	45.5	45.3	45.1	44.9	44.9	44.0	42.9	40.8	38.8	36.8	33.5
12.0	40.4	40.2	40.1	39.9	39.7	39.5	39.5	39.2	38.9	37.0	35.2	33.5	31.9
13.0	36.1	35.9	35.8	35.6	35.4	35.2	35.1	34.9	34.7	33.8	35.2	30.7	29.2
14.0	32.6	32.4	32.2	32.1	31.9	31.6	31.6	31.3	31.1	30.9	29.6	28.2	26.9
15.0	30.0/14.4	29.5	29.3	29.1	28.9	28.6	28.6	28.3	28.2	27.9	27.3	26.1	24.8
16.0		27.0	26.8	26.6	26.4	26.1	26.1	25.8	25.6	25.4	24.9	24.2	23.0
17.0		24.9	24.6	24.4	24.2	23.9	23.9	23.6	23.5	23.2	22.8	22.4	21.4
18.0		24.7/17.1	22.8	22.6	22.4	22.1	22.0	21.8	21.6	21.3	20.9	20.5	19.9
19.0			21.2	21.0	20.7	20.4	20.4	20.1	19.9	19.7	19.2	18.9	18.6
20.0			20.1/19.8	19.5	r19.3	19.0	18.9	18.7	18.5	18.2	17.7	17.4	17.1
22.0				17.2	16.9	r16.6	16.5	rr16.2	16.0	15.7	15.3	14.9	14.6
24.0				16.7/22.5	15.0	14.6	14.5	14.2	14.0	13.8	r13.3	12.9	12.6
26.0					14.1/25.1	13.1	12.9	12.6	12.4	12.1	11.6	11.3	10.9
28.0						11.8/27.9	11.16	11.3	11.1	r10.7	10.2	9.9	9.5
30.0							r10.5	10.2	9.9	r9.6	9.1	8.7	8.3
32.0								10.2/30.6	9.2	r8.9	8.6	8.0	7.7
34.0									8.7/33.3	8.1	7.7	7.2	6.8
36.0										7.4	6.9	6.4	6.0
38.0											6.3	5.7	5.3
40.0											5.7	5.2	4.7
42.0										5.4/41.4	4.6	4.2	3.8
44.0											4.2	3.7	3.3
46.0											3.8	3.3	2.9
48.0											3.6/46.8	2.9	2.5
50.0												2.6	2.1
52.0												2.3	1.8
54.0												3.6/52.2	1.5
56.0													1.2
58.0													1.0/57.6
ø [mm]	Number of strands												
36	6	6	6	5	5	4	4	4	3	3	3	2	2
34	8	7	7	6	6	5	5	4	4	3	3	3	2

Table no. 6140 R-80/2838/34.0/11.16 SH

6140E Load capacity



Main boom

Undercarriage track width 4600 mm

34.0 t outreach [m]	Boom length [m]												
	13.1	15.9	18.7	21.5	24.3	27.1	29.9	32.7	35.5	41.1	46.7	52.3	57.9
4.0	140.0	124.8/8.4	118.5/4.7										
5.0	122.5	115.5	109.5	103.0	90.6/5.4	81.7/5.7							
6.0	96.0	91.5	87.5	83.8	80.5	77.3	73.5	66.8/6.4	60.5/6.8				
7.0	75.4	75.2	72.7	70.0	67.5	65.0	63.0	60.8	58.8	52.0/7.4			
8.0	61.3	61.2	61.0	60.0	58.0	56.1	54.5	52.7	51.1	48.1	44.7/8.1	39.0/8.8	
9.0	51.5	51.4	51.2	51.1	50.8	49.2	47.9	46.5	45.1	42.6	40.2	38.1	34.1/9.5
10.0	44.3	44.1	44.0	43.8	43.7	43.5	42.6	41.4	40.2	38.2	36.1	34.2	32.4
11.0	38.8	38.6	38.4	38.2	38.1	37.9	37.8	37.3	36.6	34.5	32.6	31.0	29.4
12.0	34.4	34.2	34.0	33.8	33.7	33.5	33.4	33.2	33.0	31.3	29.7	28.2	26.7
13.0	30.8	30.6	30.5	30.3	30.2	29.9	29.8	29.7	29.4	28.6	27.2	25.8	24.5
14.0	27.9	27.7	27.5	27.3	27.2	26.9	26.8	26.7	26.5	26.1	25.0	23.7	22.5
15.0	27.0/14.4	25.2	25.0	24.8	24.7	24.5	24.4	24.2	24.0	23.6	23.1	21.9	20.8
16.0		23.2	22.9	22.7	22.6	22.3	22.2	22.0	21.8	21.5	21.1	20.3	19.2
17.0		21.4	21.1	20.9	20.8	20.5	20.4	20.2	20.0	19.6	r19.3	18.9	17.8
18.0		21.3/17.1	19.6	r19.3	19.2	18.9	18.8	18.6	18.4	18.0	17.7	17.4	r16.6
19.0			18.2	17.9	17.8	17.5	17.4	17.2	17.0	r16.6	rr16.2	16.0	15.4
20.0			17.3/19.8	16.7	r16.6	16.3	rr16.2	16.0	15.7	15.4	15.0	14.7	14.2
22.0				14.7	14.5	14.2	14.1	13.9	r13.6	r13.3	12.9	12.6	12.1
24.0				14.3/22.5	12.8	12.5	12.4	12.1	r11.9	11.5	11.1	r10.8	10.4
26.0					12.0/25.1	11.1	r11.0	r10.7	r10.5	10.1	9.7	9.4	r8.9
28.0						10.1/27.9	9.8	r9.6	9.3	r8.9	8.5	8.2	7.7
30.0							r8.9	8.6	8.3	7.9	7.5	7.1	6.7
32.0							8.6/30.6	7.7	7.5	7.0	6.6	6.2	5.8
34.0								7.3/33.3	6.7	6.3	5.8	5.5	5.0
36.0									6.1	5.6	5.1	4.8	4.3
38.0										5.0	4.6	4.2	3.7
40.0										4.6	4.0	3.7	3.2
42.0										4.3/41.4	3.6	3.2	2.7
44.0											3.2	2.8	2.2
46.0											2.8	2.4	1.9
48.0											2.7/41.4	2.0	1.5
50.0												1.7	1.2
52.0												1.5	0.9
54.0												1.4/52.2	
ø [mm]	Number of strands												
36	6	6	6	5	5	4	4	4	3	3	3	2	2
34	8	7	7	6	6	5	5	4	4	3	3	3	2

Table no. 6140 R-80/2388/34.0/11.16 SH

Number of strands and load capacity*

For 300 kN/350 kN winches with 36 mm rope diameter

For 250 kN winches with 34 mm rope diameter

Capacity	Weight	Rope strands & max. load capacity					
		7	6	5	4	3	2
30 t	500 kg						24000
70 t - 1 roll	1000 kg			70000	48000	24000	
120 t - 2 rolls	1100 kg	120000	96000	72000	48000	24000	
150 t - 3 rolls	1200 kg	140000	120000	96000	72000	48000	24000

Capacity	Weight	Rope strands & max. load capacity						
		7	6	5	4	3	2	1
20 t	550 kg							20000
60 t - 1 roll	950 kg					60000	40000	20000
100 t - 2 Rolls	1100 kg			10000	80000	60000	40000	20000
140 t - 3 Rolls	1500 kg	140000	120000	10000	80000	60000	40000	20000

6140E Diaphragm wall claw equipment

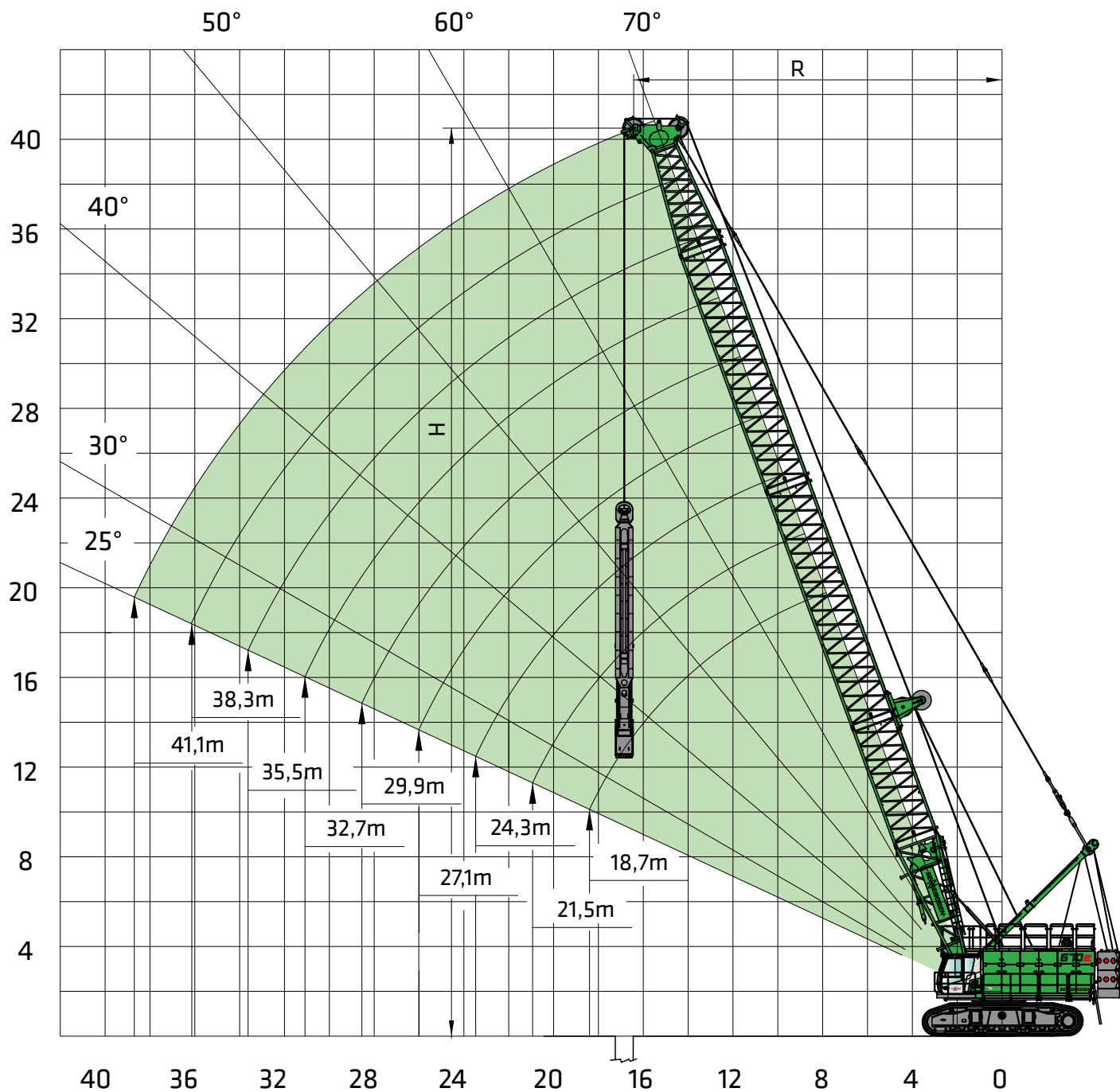

Notes:

1. The specified safe working load values apply to ensure level and firm standing of the machine.
2. The safe working load values are specified in tons (t) and apply for 360 degrees.
3. The load ratings do not exceed 60% of the tilt load.
4. The safe working load values apply for the maximum undercarriage track width of 600/5500 mm.
5. Deduct the weight of the load handling devices (hook, suspension gear) from the load ratings.
6. Hoisting a load that exceeds the maximum winch pulling force of one winch is only allowed if each winch is not overloaded.

Winch pulling force [kN]	250	300	350
Rope diameter [mm]	34	36	36
Minimum tensile strength [kN]	888	1065	1243
max. safe working load in single-winch operation [t]	25.0	30.0	35.0
max. working load in double-winch operation [t]	37.9	45.5	53.0

Load capacity

Diaphragm wall claw equipment
Undercarriage track width 5500 mm

34.0 t outreach [m]	Boom length [m]									
	13.1	15.9	18.7	21.5	24.3	27.1	29.9	32.7	35.5	41.1
4.0	53.0	53.0/4.4	53.0/4.7							
5.0	53.0	53.0	53.0	53.0	53.0/5.4	53.0/5.7				
6.0	53.0	53.0	53.0	53.0	53.0	53.0	53.0	53.0/6.4	53.0/6.8	
7.0	53.0	53.0	53.0	53.0	53.0	53.0	53.0	53.0	53.0	53.0/7.4
8.0	53.0	53.0	53.0	53.0	53.0	53.0	53.0	53.0	53.0	51.6
9.0	47.7	47.6	47.6	47.5	47.4	47.3	47.2	47.1	47.0	46.0
10.0	40.7	40.6	40.6	40.4	40.3	40.2	40.1	40.0	39.9	39.6
11.0	35.4	35.3	35.3	35.1	35.0	34.9	34.8	34.7	34.5	34.3
12.0	31.3	31.2	31.1	31.0	30.9	30.7	30.6	30.5	30.4	30.1
13.0	27.9	27.8	27.8	27.6	27.5	27.4	27.3	27.1	27.0	26.7
14.0	25.2	25.1	25.0	24.9	24.8	24.6	24.5	24.4	24.2	24.0
15.0	24.3/14.4	22.8	22.7	22.6	22.5	22.3	22.2	22.1	21.9	21.7
16.0		20.9	20.8	20.7	20.5	20.4	20.3	20.1	20.0	19.7
17.0		19.2	19.2	19.0	18.9	18.7	18.6	18.5	18.3	18.0
18.0		19.1/17.1	17.7	17.6	17.4	17.3	17.2	17.0	16.9	r16.6
19.0			16.4	16.3	rr16.2	16.0	15.9	15.7	15.6	15.3
20.0			15.6/19.8	15.2	15.0	14.9	14.8	14.6	14.5	14.2
22.0				r13.3	13.2	13.0	12.9	12.7	12.6	12.3
24.0				12.9/22.5	11.6	11.5	11.4	11.2	r11.0	r10.7
26.0					10.9/25.1	10.2	10.1	9.9	9.8	9.5
28.0						9.2/27.9	9.1	r8.9	8.7	8.4
30.0							8.2	8.0	7.8	7.5
32.0							7.9/30.6	7.2	7.0	6.7
34.0								6.8/33.3	6.4	6.0
36.0									5.8	5.4
38.0										4.9
40.0										4.5
42.0										4.2/41.4

Table no. 6140 R-60/2838/34.0/10.17 5H

Diaphragm wall claw equipment
Undercarriage track width 4600 mm

34.0 t outreach [m]	Boom length [m]									
	13.1	15.9	18.7	21.5	24.3	27.1	29.9	32.7	35.5	41.1
4.0	53.0	53.0/4.4	53.0/4.7							
5.0	53.0	53.0	53.0	53.0	53.0/5.4	53.0/5.7				
6.0	53.0	53.0	53.0	53.0	53.0	53.0	53.0	53.0/6.4	53.0/6.8	
7.0	53.0	53.0	53.0	53.0	53.0	53.0	53.0	53.0	53.0	46.7/7.4
8.0	47.4	47.3	47.2	47.1	47.0	46.9	46.8	46.7	46.5	43.4
9.0	39.9	39.7	39.7	39.5	39.4	39.3	39.2	39.1	39.0	38.7
10.0	34.3	34.2	34.1	34.0	33.9	33.7	33.6	33.5	33.3	33.1
11.0	30.0	29.9	29.8	29.7	29.6	29.4	29.3	29.2	29.0	28.8
12.0	26.6	26.5	26.4	26.3	26.2	26.0	25.9	25.8	25.6	25.3
13.0	23.9	23.8	23.7	23.5	23.4	23.2	23.2	23.0	22.8	22.6
14.0	21.6	21.5	21.4	21.2	21.1	21.0	20.9	20.7	20.6	20.3
15.0	20.9/14.4	19.6	19.5	r19.3	19.2	19.0	19.0	18.8	18.6	18.3
16.0		17.9	17.9	17.7	17.6	17.4	17.3	17.1	17.0	16.7
17.0		16.5	16.4	16.3	rr16.2	16.0	15.9	15.7	15.6	15.3
18.0		16.4/17.1	15.2	15.1	14.9	14.7	14.7	14.5	14.3	14.0
19.0			14.1	14.0	13.8	13.7	r13.6	13.4	13.2	12.9
20.0			13.4/19.8	13.0	12.9	12.7	12.6	12.4	12.3	12.0
22.0				11.4	11.3	11.1	r11.0	r10.8	r10.7	10.03
24.0				11.1/22.5	10.0	9.8	9.7	9.5	9.3	9.0
26.0					9.3/25.1	8.7	8.6	8.4	8.2	7.9
28.0						7.8/27.9	7.7	7.5	7.3	7.0
30.0							6.9	6.7	6.5	6.2
32.0							6.7/30.6	6.0	5.8	5.5
34.0								5.6/33.3	5.3	4.9
36.0									4.8	4.4
38.0										4.0
40.0										3.6
42.0										3.3/41.4

Table no. 6140 R-60/2388/34.0/10.17 5H

6140E Grab equipment

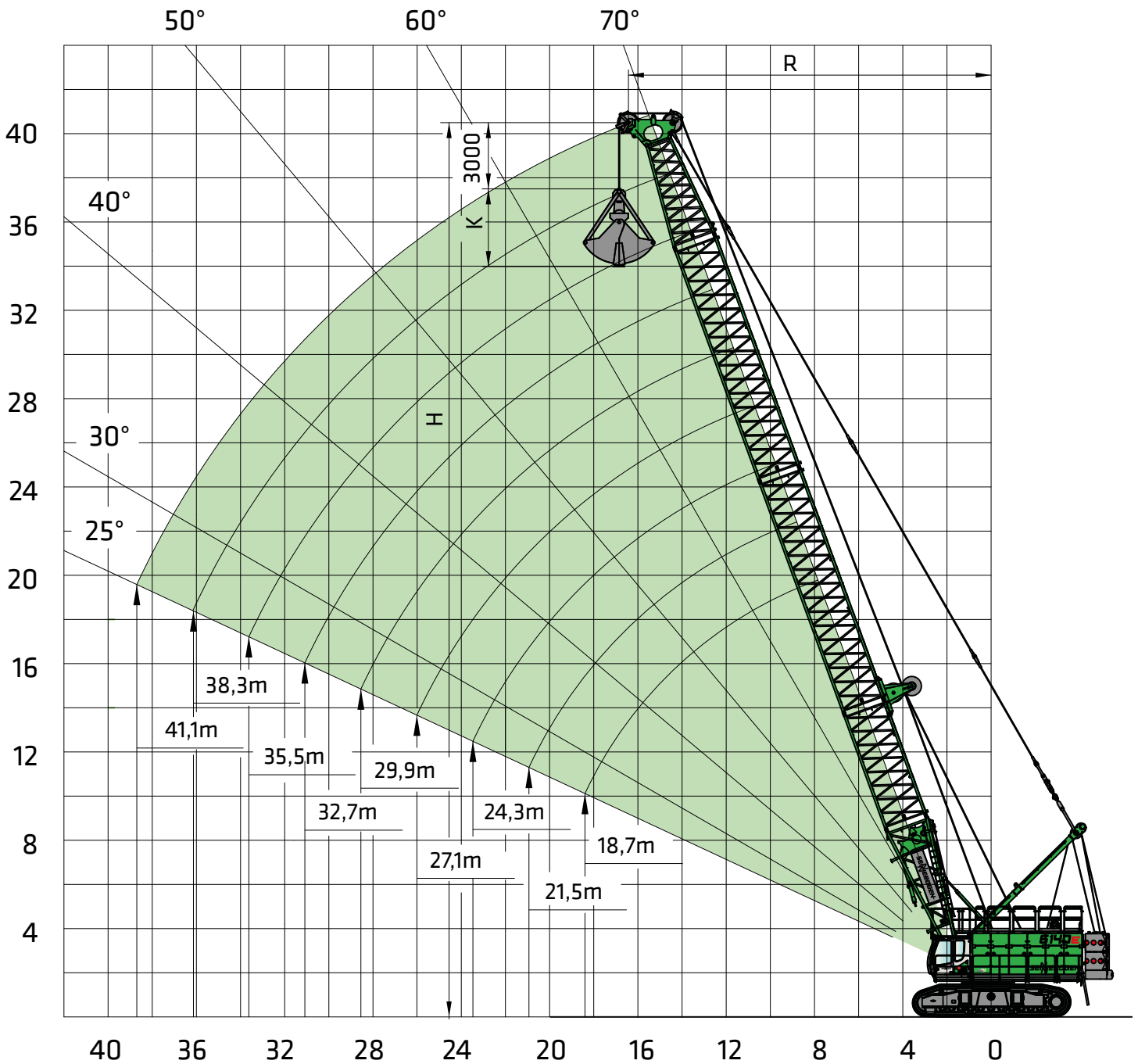

Notes:

1. The specified safe working load values apply to ensure level and firm standing of the machine.
2. The safe working loads are given in tons and apply for 360 °C.
3. The load ratings do not exceed 66.7% of the tilt load.
4. The safe working load values apply for the maximum undercarriage track width of 4600/5500 mm.
5. Deduct the weight of the load handling devices (hook, suspension gear) from the load ratings.
6. Hoisting a load that exceeds the maximum winch pulling force of one winch is only allowed if each winch is not overloaded.

Winch pulling force [kN]	50	300	350
Rope diameter [mm]	34	36	36
Minimum tensile strength [kN]	888	1065	1243
max. safe working load in single-winch operation [t]	25.0	30.0	35.0
max. working load in double-winch operation [t]	37.9	45.5	53.0

Load capacity

Grab equipment Undercarriage track width 4600 mm

 34 t Boom angle alpha [°]	Boom length [m]																										
	18.7			21.5			24.3			27.1			29.9			32.7			35.5			38.3			41.1		
	R	H		R	H		R	H		R	H		R	H		R	H		R	H		R	H		R	H	
	m	m	t	m	m	t	m	m	t	m	m	t	m	m	t	m	m	t	m	m	t	m	m	t	m	m	t
70	8.8	17.2	44.4	9.7	19.9	38.1	10.7	22.5	33.2	11.6	25.1	29.3	12.6	27.8	26.2	13.6	30.4	23.5	14.5	33.0	21.2	15.5	35.7	19.2	16.4	38.3	17.5
65	10.2	16.5	35.5	11.4	19.1	30.3	12.6	21.6	26.4	13.8	24.1	23.2	15.0	26.7	20.6	16.2	29.2	18.4	17.3	31.8	16.5	18.5	34.3	14.8	19.7	36.8	13.4
60	11.6	15.7	29.7	13.0	18.1	25.3	14.4	20.6	21.9	15.8	23.0	19.1	17.2	25.4	16.9	18.6	27.8	15.0	20.0	30.3	13.4	21.4	32.7	11.9	22.8	35.1	10.7
55	13.0	14.8	25.6	14.6	17.0	21.7	16.2	19.3	18.7	17.8	21.6	16.3	19.4	23.9	14.4	21.0	26.2	12.7	22.6	28.5	11.2	24.2	30.8	9.9	25.8	33.1	8.9
50	14.2	13.7	22.6	16.0	15.8	19.1	17.8	18.0	16.4	19.6	20.1	14.2	21.4	22.3	12.5	23.2	24.4	10.9	25.0	26.6	9.6	26.8	28.7	8.5	28.6	30.9	7.5
45	15.4	12.5	20.4	17.3	14.5	17.2	19.3	16.5	14.7	21.3	18.5	12.7	23.3	20.4	11.1	25.3	22.4	9.7	27.2	24.4	8.5	29.2	26.4	7.4	31.2	28.4	6.5
40	16.4	11.3	18.7	18.5	13.1	15.7	20.7	14.9	13.4	22.8	16.7	11.5	25.0	18.5	10.0	27.1	20.3	8.7	29.3	22.1	7.6	31.4	23.9	6.5	33.6	25.7	5.7
35	17.3	9.9	17.4	19.6	11.5	14.5	21.9	13.1	12.4	24.2	14.7	10.6	26.5	16.3	9.2	28.8	18.0	7.9	31.1	19.6	6.9	33.4	21.2	5.9	35.7	22.8	5.1
30	18.1	8.5	16.3	20.6	9.9	13.6	23.0	11.3	11.6	25.4	12.7	9.9	27.8	14.1	8.5	30.3	15.5	7.3	32.7	16.9	6.3	35.1	18.3	5.4	37.5	19.7	4.7
25	18.8	7.0	15.6	21.3	8.2	13.0	23.9	9.4	11.0	26.4	10.6	9.3	29.0	11.7	8.1	31.5	12.9	6.9	34.0	14.1	5.9	36.6	15.3	5.0	39.1	16.5	4.3

Grab equipment Undercarriage track width 5500 mm

 34 t Boom angle alpha [°]	Boom length [m]																										
	18.7			21.5			24.3			27.1			29.9			32.7			35.5			38.3			41.1		
	R	H		R	H		R	H		R	H		R	H		R	H		R	H		R	H		R	H	
	m	m	t	m	m	t	m	m	t	m	m	t	m	m	t	m	m	t	m	m	t	m	m	t	m	m	t
70	8.8	17.2	53.0	9.7	19.9	45.3	10.7	22.5	39.3	11.6	25.1	34.6	12.6	27.8	30.8	13.6	30.4	27.6	14.5	33.0	24.9	15.5	35.7	22.5	16.4	38.3	20.6
65	10.2	16.5	42.1	11.4	19.1	35.8	12.6	21.6	31.0	13.8	24.1	27.1	15.0	26.7	24.1	16.2	29.2	21.5	17.3	31.8	19.3	18.5	34.3	17.4	19.7	36.8	15.8
60	11.6	15.7	34.9	13.0	18.1	29.6	14.4	20.6	25.6	15.8	23.0	22.3	17.2	25.4	19.8	18.6	27.8	17.5	20.0	30.3	15.7	21.4	32.7	14.0	22.8	35.1	12.7
55	13.0	14.8	30.0	14.6	17.0	25.4	16.2	19.3	21.8	17.8	21.6	19.0	19.4	23.9	16.8	21.0	26.2	14.8	22.6	28.5	13.2	24.2	30.8	11.7	25.8	33.1	10.5
50	14.2	13.7	26.4	16.0	15.8	22.3	17.8	18.0	19.1	19.6	20.1	16.6	21.4	22.3	14.6	23.2	24.4	12.8	25.0	26.6	11.4	26.8	28.7	10.0	28.6	30.9	9.0
45	15.4	12.5	23.7	17.3	14.5	20.0	19.3	16.5	17.1	21.3	18.5	14.8	23.3	20.4	13.0	25.3	22.4	11.3	27.2	24.4	10.0	29.2	26.4	8.8	31.2	28.4	7.8
40	16.4	11.3	21.7	18.5	13.1	18.2	20.7	14.9	15.6	22.8	16.7	13.4	25.0	18.5	11.7	27.1	20.3	10.2	29.3	22.1	9.0	31.4	23.9	7.8	33.6	25.7	6.9
35	17.3	9.9	20.2	19.6	11.5	16.9	21.9	13.1	14.4	24.2	14.7	12.3	26.5	16.3	10.8	28.8	18.0	9.3	31.1	19.6	8.2	33.4	21.2	7.1	35.7	22.8	6.2
30	18.1	8.5	19.0	20.6	9.9	15.8	23.0	11.3	13.5	25.4	12.7	11.5	27.8	14.1	10.0	30.3	15.5	8.7	32.7	16.9	7.5	35.1	18.3	6.5	37.5	19.7	5.7
25	18.8	7.0	18.0	21.3	8.2	15.0	23.9	9.4	12.8	26.4	10.6	10.9	29.0	11.7	9.5	31.5	12.9	8.2	34.0	14.1	7.1	36.6	15.3	6.1	39.1	16.5	5.3

6140E Dragline bucket equipment

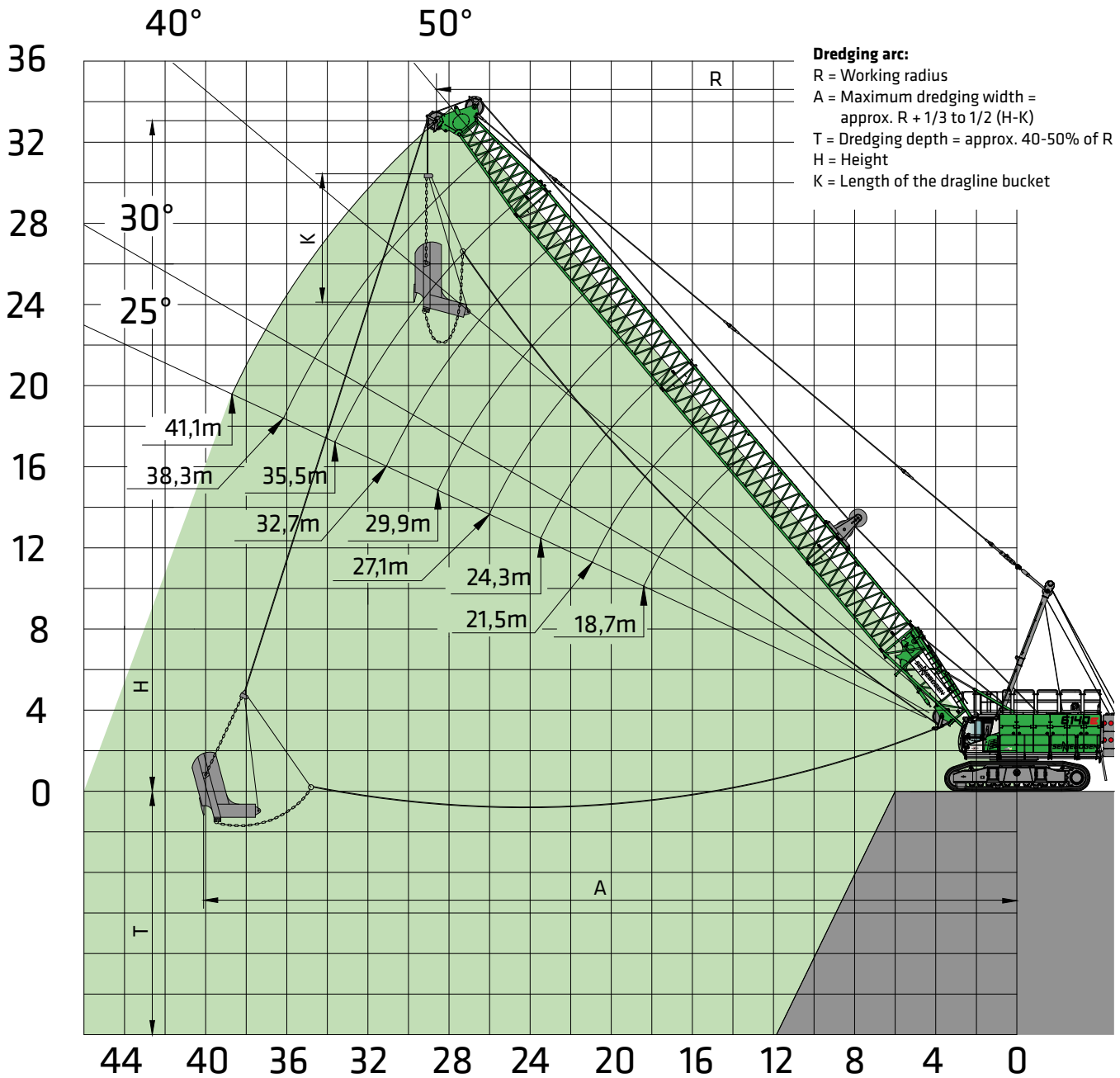

Notes:

1. The specified safe working load values apply to ensure level and firm standing of the machine.
2. The safe working loads are given in tons and apply for 360 °C.
3. The specified safe working loads include the diaphragm wall weight and do not exceed 75% of the tipping load.
4. The safe working load values apply for the maximum undercarriage track width of 4600/5500 mm.
5. For operation with a mechanical two-rope grapple and even load distribution on the closing and holding ropes, the safe working load is limited by the permissible rope tension or the maximum winch pulling force of a winch..

Winch pulling force [kN]	250	300	350
Rope diameter [mm]	34	36	36
Minimum tensile strength [kN]	888	1065	1243
max. safe working load in drag bucket operation [t]	25.0	30.0	35.0

Load capacity

Dragline bucket equipment Undercarriage track width 4600 mm

 34 t Boom angle alpha [°]	Boom length [m]																										
	18.7			21.5			24.3			27.1			29.9			32.7			35.5			38.3			41.1		
	R	H		R	H		R	H		R	H		R	H		R	H		R	H		R	H		R	H	
	m	m	t	m	m	t	m	m	t	m	m	t	m	m	t	m	m	t	m	m	t	m	m	t	m	m	t
55	13.0	14.8	28.8	14.6	17.0	24.4	16.2	19.3	21.1	17.8	21.6	18.3	19.4	23.9	16.2	21.0	26.2	14.2	22.6	28.5	12.6	24.2	30.8	11.2	25.8	33.1	10.0
50	14.2	13.7	25.5	16.0	15.8	21.5	17.8	18.0	18.5	19.6	20.1	16.0	21.4	22.3	14.1	23.2	24.4	12.3	25.0	26.6	10.8	26.8	28.7	9.5	28.6	30.9	8.4
45	15.4	12.5	23.0	17.3	14.5	19.3	19.3	16.5	16.5	21.3	18.5	14.3	23.3	20.4	12.5	25.3	22.4	10.9	27.2	24.4	9.5	29.2	26.4	8.3	31.2	28.4	7.3
40	16.4	11.3	21.0	18.5	13.1	17.6	20.7	14.9	15.1	22.8	16.7	12.9	25.0	18.5	11.3	27.1	20.3	9.8	29.3	22.1	8.5	31.4	23.9	7.4	33.6	25.7	6.4
35	17.3	9.9	19.5	19.6	11.5	16.3	21.9	13.1	13.9	24.2	14.7	11.9	26.5	16.3	10.3	28.8	18.0	8.9	31.1	19.6	7.7	33.4	21.2	6.6	35.7	22.8	5.8
30	18.1	8.5	18.4	20.6	9.9	15.3	23.0	11.3	13.0	25.4	12.7	11.1	27.8	14.1	9.6	30.3	15.5	8.3	32.7	16.9	7.1	35.1	18.3	6.1	37.5	19.7	5.2
25	18.8	7.0	17.5	21.3	8.2	14.6	23.9	9.4	12.3	26.4	10.6	10.5	29.0	11.7	9.1	31.5	12.9	7.8	34.0	14.1	6.7	36.6	15.3	5.7	39.1	16.5	4.8

Dragline bucket equipment Undercarriage track width 5500 mm

 34 t Boom angle alpha [°]	Boom length [m]																										
	18.7			21.5			24.3			27.1			29.9			32.7			35.5			38.3			41.1		
	R	H		R	H		R	H		R	H		R	H		R	H		R	H		R	H		R	H	
	m	m	t	m	m	t	m	m	t	m	m	t	m	m	t	m	m	t	m	m	t	m	m	t	m	m	t
55	13.0	14.8	33.7	14.6	17.0	28.5	16.2	19.3	24.6	17.8	21.6	21.4	19.4	23.9	18.9	21.0	26.2	16.7	22.6	28.5	14.8	24.2	30.8	13.2	25.8	33.1	11.8
50	14.2	13.7	29.7	16.0	15.8	25.1	17.8	18.0	21.5	19.6	20.1	18.7	21.4	22.3	16.4	23.2	24.4	14.4	25.0	26.6	12.8	26.8	28.7	11.3	28.6	30.9	10.1
45	15.4	12.5	26.7	17.3	14.5	22.5	19.3	16.5	19.2	21.3	18.5	16.6	23.3	20.4	14.6	25.3	22.4	12.8	27.2	24.4	11.2	29.2	26.4	9.9	31.2	28.4	8.8
40	16.4	11.3	24.4	18.5	13.1	20.5	20.7	14.9	17.5	22.8	16.7	15.1	25.0	18.5	13.2	27.1	20.3	11.5	29.3	22.1	10.1	31.4	23.9	8.8	33.6	25.7	7.8
35	17.3	9.9	22.7	19.6	11.5	19.0	21.9	13.1	16.2	24.2	14.7	13.9	26.5	16.3	12.1	28.8	18.0	10.5	31.1	19.6	9.2	33.4	21.2	8.0	35.7	22.8	7.0
30	18.1	8.5	21.3	20.6	9.9	17.8	23.0	11.3	15.2	25.4	12.7	13.0	27.8	14.1	11.3	30.3	15.5	9.8	32.7	16.9	8.5	35.1	18.3	7.3	37.5	19.7	6.4
25	18.8	7.0	20.3	21.3	8.2	16.9	23.9	9.4	14.4	26.4	10.6	12.3	29.0	11.7	10.6	31.5	12.9	9.2	34.0	14.1	8.0	36.6	15.3	6.9	39.1	16.5	6.0

6140E Base Machine Dimensions

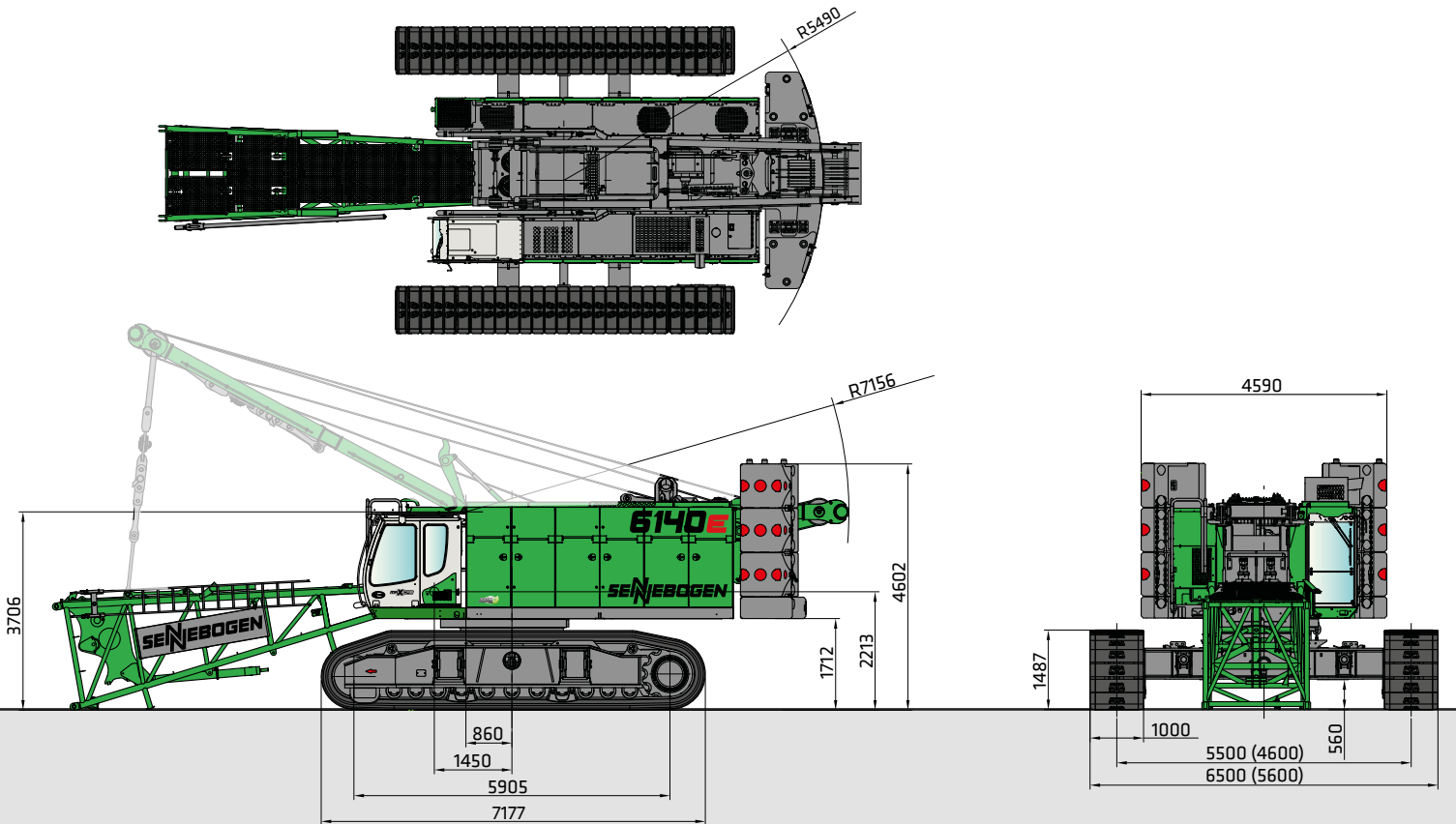

6140E Transport dimensions and weights

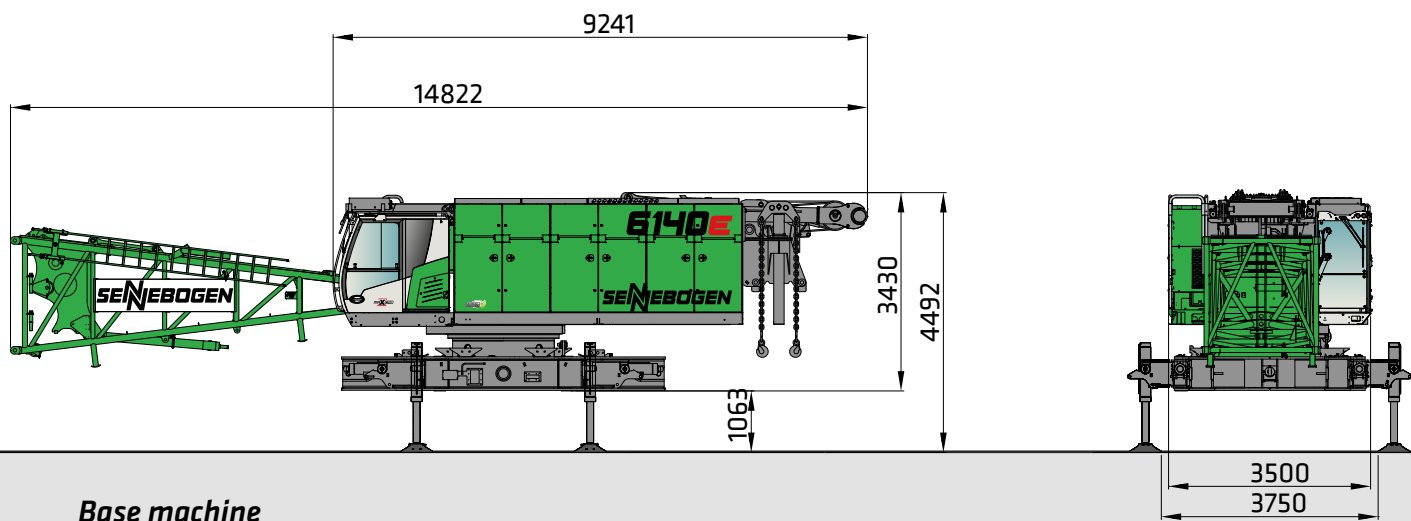

Base machine

- with stay rack, self-assembly system, Ballast storage equipment, 2 x 35 t (2 x 25 t) freefall winches, CAT engine C27 (C18)
- without traveling gear, without ballast, without lifting ropes
- with lower boom section

Transport weight: 58.7 t (55.1 t)

Weight of lifting ropes 36 mm/34 mm: 6.4 kg/m, 5.7 kg/m

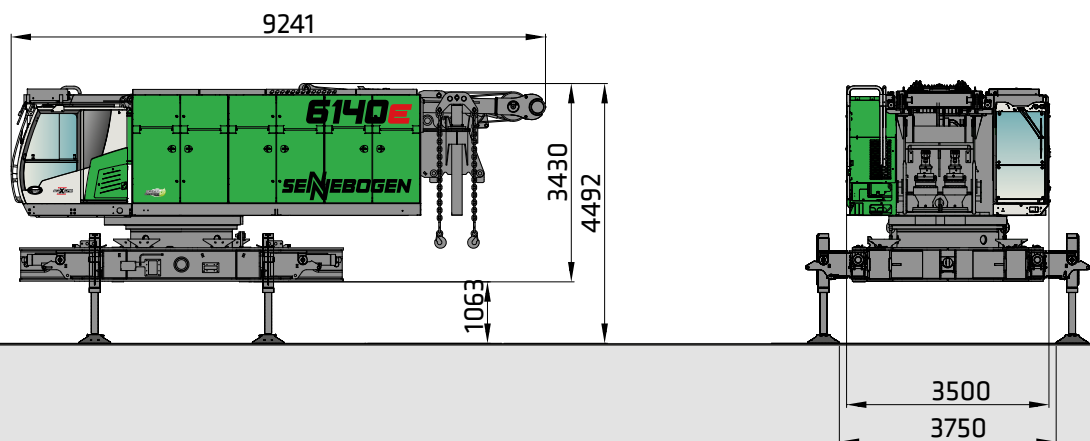

Base machine

- with stay rack, self-assembly system, Ballast storage equipment 2 x 35 t (2 x 25 t) freefall winches, CAT engine C27 (C18)
- without traveling gear, without ballast, without lifting ropes, without boom base

Transport weight: 54.5 t (50.9 t)

Weight of lifting ropes 36 mm/34 mm: 6.4 kg/m, 5.7 kg/m

6140E Transport dimensions and weights

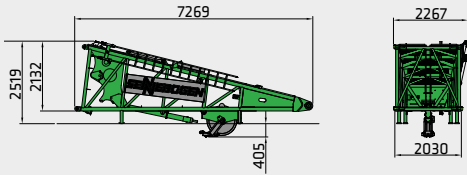

Lower boom section 7 m, SH type 2008

Complete equipment: 4950 kg

Basic equipment: 4180 kg

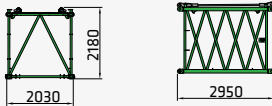

Intermediate boom section 2.8 m, SH type 2008
(with anchoring ropes)

Weight: 650 kg / 710 kg

(500 mm/1690 mm wide walkway)

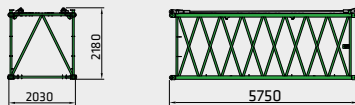

Intermediate boom section 5.6 m, SH type 2008
(with anchoring ropes)

Weight: 1080 kg / 1200 kg

(500 mm/1690 mm wide walkway)

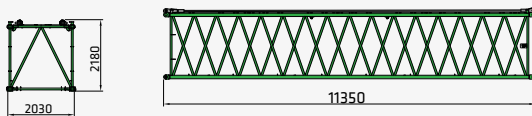

Intermediate boom section 11.2 m, SH type 2008
(with anchoring ropes)

Weight: 1980 kg / 2210 kg

(500 mm/1690 mm wide walkway)



Boom headpiece 6.1 m, SH type 2008
(with anchoring ropes)

Weight: 2850 kg / 2950 kg

(500 mm/1690 mm wide walkway)

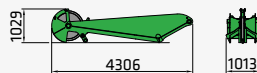

S 24.1 auxiliary jib

Weight: 705 kg

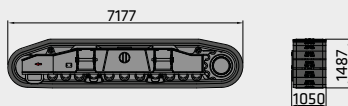

2x crawler

(B9HDS, 1000 mm flat base plate)

Weight: 16000 kg (2 x)

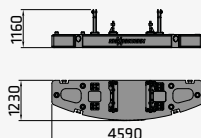

Ballast base plate

weight 12000 kg

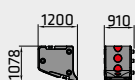

Counterweight 6x / 4x

(counterweight 45 t/ 34 t)

Weight: 5500 kg (6 x / 4 x)



6140E Self-assembly system

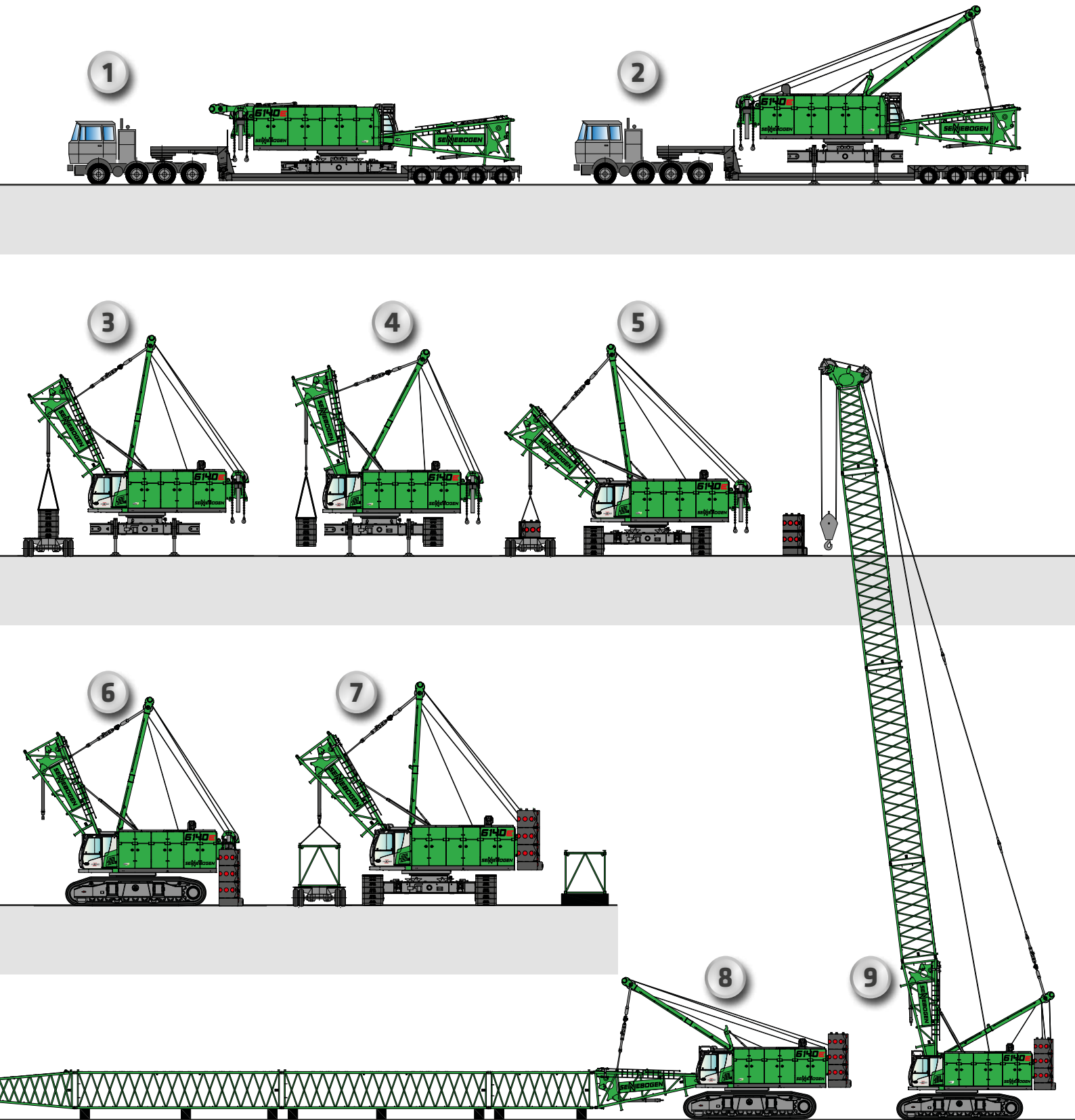

6140E

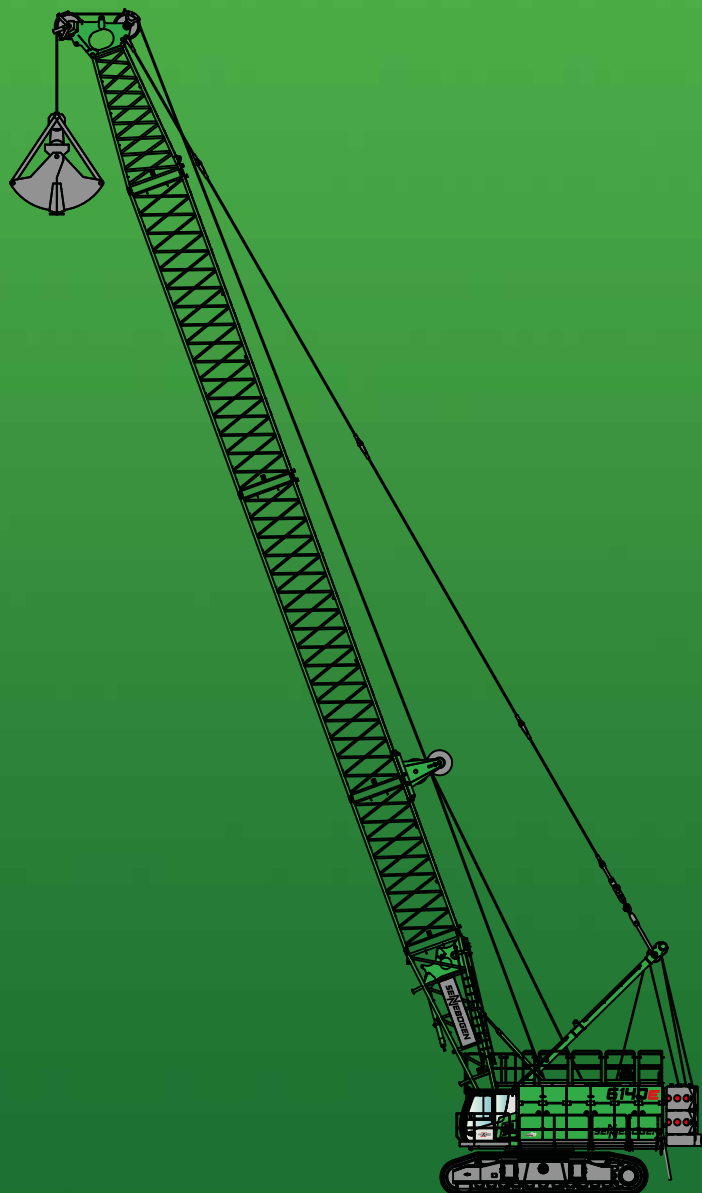

This catalog describes machine models, scopes of equipment of individual models, and configuration options (standard equipment and optional equipment) of the machines supplied by SENNEBOGEN Maschinenfabrik GmbH. Machine illustrations can contain optional equipment and supplemental equipment. Actual equipment may vary depending on the country to which the machines are delivered, especially in regard to standard and optional equipment. All product designations used may be trademarks of SENNEBOGEN Maschinenfabrik GmbH or other supplying companies, and any use by third parties for their own purposes may violate the rights of the owners.

Please contact your local SENNEBOGEN sales partner for information concerning the equipment variants offered. Requested performance characteristics are only binding if they are expressly stipulated upon conclusion of the contract. Delivery options and technical features are subject to change. Errors and omissions excepted. Equipment is subject to change, and rights of advancement are reserved. © SENNEBOGEN Maschinenfabrik GmbH, Straubing, Germany. Reproduction in whole or in part only with written consent of SENNEBOGEN Maschinenfabrik GmbH, Straubing, Germany.

SENNEBOGEN

SENNEBOGEN
Maschinenfabrik GmbH
Sennebogenstraße 10
94315 Straubing, Germany

Tel. +49 9421 540-144/146
marketing@sennebogen.de

Item No. 299199
6140R-E-02180750-1019d

GO FOR GREEN

 www.sennebogen.com