



GRT8120

Preliminary Product Guide

ANSI B30.5
Imperial 85%

Features

- 120 t (120 USt) capacity
- 11,3 m - 60 m (37.2 ft - 197 ft) seven-section MEGAFORM™ boom
- 10,5 m - 17,6 m (34.5 ft - 57.6 ft) manual or hydraulic bi-fold lattice swingaway extension with offsets up to 45°
- Crane Control System (CCS)
- New wider full vision cab with 20° cab tilt
- MAXbase variable outrigger positioning system

GROVE GRT8120

The GRT8120 was designed after gathering feedback from crane owners and operators to ensure that it is loaded with the features and reliability you demand.

Features

> Unmatched reach with compact carrier

Class-leading lifting performance is enhanced by the 11,3 m to 60 m (37.2 ft to 197 ft) seven-section MEGAFORM™ boom with TWIN-LOCK™ boom pinning system. This amount of main boom length is typically reserved for rough terrain cranes in the 135 t - 150 t (150 US t - 165 US t) class, however when combined with a compact carrier with dimensions of cranes in the 70 t - 90 t (80 US t - 100 US t) class, make the GRT8120 a truly versatile crane that should be in every crane owners fleet. Boosting overall reach is the 17,6 m (57.6 ft) manual or hydraulic swingaway jib for a maximum tip height of 80,8 m (265 ft).

> MAXbase variable outrigger positioning

MAXbase provides increased versatility on the jobsite by allowing asymmetrical outrigger spans. This makes it easier to work in congested jobsites with obstructions, and allows for increased capacities when comparing to the standard 360° load charts.

> New wider full vision cab

The new wider full vision cab was designed with operator comfort, visibility and productivity in mind. Additional width, redesigned armrests and 20° cab tilt maximize the operator experience. Standard features include tilt/telescoping steering wheel, USB charging port, electronic seat adjustments, high-output heating and air conditioning system, large pivoting cup holder, windshield sun visor, added storage behind the seat, and three camera package. Additional optional equipment includes radio with Bluetooth and heated seat.

> Backing up our promise

Our new GRT line of Rough Terrain cranes have been designed from the ground up to provide class-leading specifications, and have undergone extensive testing to ensure they provide industry-leading quality and reliability. We stand behind our new line of GRT cranes, and we are willing to prove it. With new three, four or five-year extended warranty programs as well as a new two-year standard warranty, our GRT line of cranes are built to be GROVE. REAL. TOUGH.



**THE ONLY FIVE-YEAR
WARRANTY PROGRAM
AVAILABLE IN THE INDUSTRY**

GRT8120 benefits

- > Class-leading boom length and capacities maximize utilization.
- > Compact dimensions with self-rigging counterweight allow for efficient and easy transportation to the job.
- > Wireless rigging remote enables fast and convenient setup.
- > Flat aluminum decking, additional storage compartments and a full LED lighting package with new side-mounted carrier lights improve access and jobsite set up.
- > MAXbase variable outrigger positioning system - Increased lift capacities and easy access to any jobsite.
- > TWIN-LOCK™ boom pinning system maximizes capacities by reducing weight inside the extended boom.
- > Boom Configurator mode increases efficiency and simplifies telescoping operation.
- > Manual or hydraulic bi-fold swingaway with offset capability to 45° increases ability to reach over obstacles and increases jobsite versatility.
- > Innovative smart-sensing outrigger monitoring system offers reliable accuracy.
- > ECO mode supports intelligent power management and decreased fuel consumption.
- > New wider cab with 20° cab tilt and high-output heating and air conditioning system maximizes operator comfort.
- > Four modes of steering increase jobsite maneuverability and make crane positioning easier.



Manitowoc Crane Care when you need it.

The assurance of the world's most advanced crane service and support to get you back to work fast.



Manitowoc Finance helps you get right to work generating profits for your business.

Financial tools that help you capitalize on opportunity with solutions that fit your needs.

Contents

- Dimensions 5
- Weights 6
- Working range with main boom and bi-fold extension7
- Load chart for main boom 8
- Load chart for MAXbase 20° over outriggers 9
- Load chart for manual bi-fold extension 10
- Load handling 12
- Specifications 13
- Symbols glossary 15

Dimensions

Tire size: 29.5 x 25

| A | B | C | D | E | F | G | A | B | C | D | E | F | G |
|--------------------|--------------------|--------------------|--------------------|--------------------|--------------------|-------------------|--------------------|--------------------|-------------------|-------------------|-------------------|-------------------|-------------------|
| 17526 mm (690") | 16713 mm (658") | 14630 mm (576") | 13970 mm (550") | 13564 mm (534") | 11278 mm (444") | 9957 mm (392") | 11938 mm (470") | 11227 mm (442") | 8664 mm (341") | 7798 mm (307") | 7493 mm (295") | 4826 mm (190") | 4521 mm (178") |
| Two-wheel steer | | | | | | | Four-wheel steer | | | | | | |

Dimensions in mm (in) unless otherwise specified.

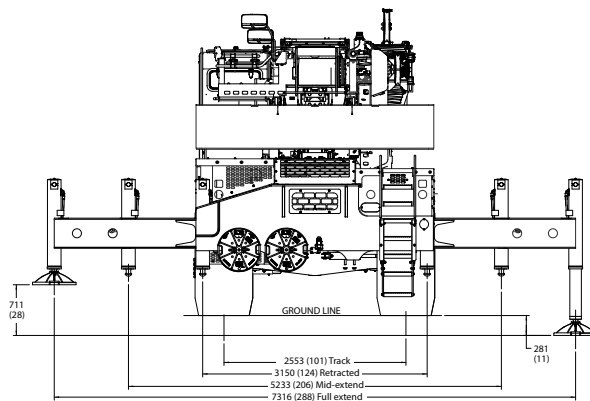
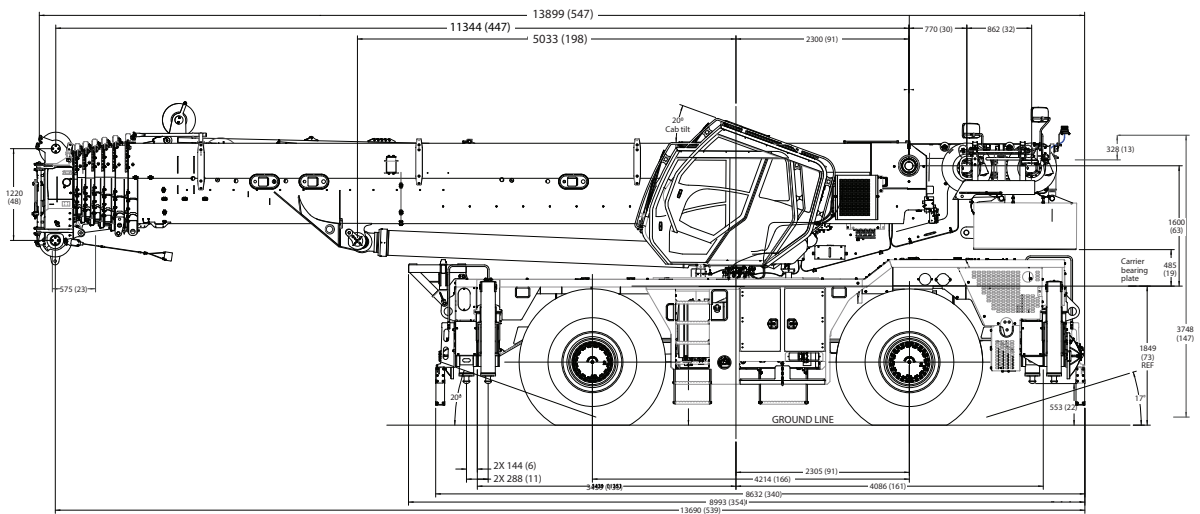
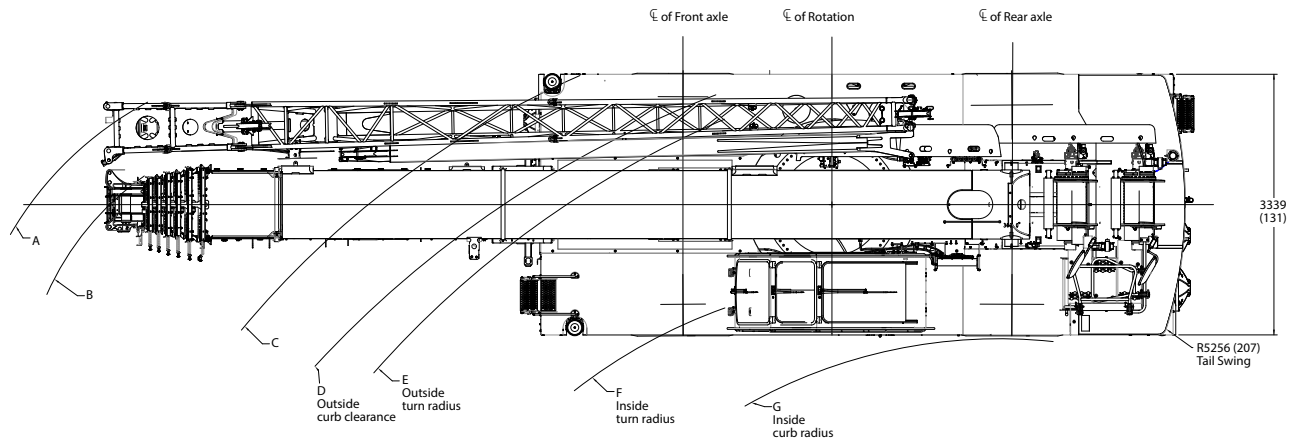

Weights

| Weights | | | | | | |
|--|---------|---------|--------|--------|---------|---------|
| | Gross | | Axle 1 | | Axle 2 | |
| | kg | lb | kg | lb | kg | lb |
| Basic crane with Cummins T4F engine, 60 m (197 ft) main boom, main and auxiliary hoist with wire rope, 17.6 m (57.6 ft) manually offset bi-fold swingaway, 75 t (83 USt) hookblock, 11 t (12 USt) overhaul weight, auxiliary boom nose and 13 245 kg (29,200 lbs) counterweight | 58,917 | 129,889 | 28,597 | 63,045 | 30,320 | 66,845 |
| Remove 13 245 kg (29,200 lb) counterweight | -13,245 | -29,200 | 4,931 | 10,871 | -18,176 | -40,071 |
| crane weight | 45,672 | 100,689 | 33,528 | 73,916 | 12,144 | 26,774 |
| Remove 17.6 m (57.6 ft) manually offset bi-fold swingaway | -1,450 | -3,197 | -2,423 | -5,342 | 973 | 2,145 |
| crane weight | 44,222 | 97,492 | 31,105 | 68,574 | 13,117 | 28,919 |
| Remove Auxiliary boom nose | -88 | -194 | -259 | -570 | 171 | 376 |
| crane weight | 44,134 | 97,298 | 30,846 | 68,004 | 13,288 | 29,295 |
| Remove 11 t (12 USt) overhaul weight | -294 | -648 | -471 | -1,038 | 177 | 390 |
| crane weight | 43,840 | 96,650 | 30,375 | 66,966 | 13,465 | 29,685 |
| Remove 75 t (83 USt) hookblock | -1,070 | -2,359 | -1,715 | -3,780 | 645 | 1,421 |
| crane weight | 42,770 | 94,291 | 28,661 | 63,186 | 14,109 | 31,106 |
| Basic crane as noted above: Substitute 10.5 m - 17.6 m (34.5 ft - 57.6 ft) hydraulically offset bi-fold swingaway and stowage brackets ILO standard manual bi-fold swingaway | 231 | 509 | 537 | 1,183 | -306 | -674 |
| crane weight | 59,148 | 130,398 | 29,134 | 64,228 | 30,014 | 66,171 |

*THIS CHART IS ONLY A GUIDE AND SHOULD NOT BE USED TO OPERATE THE CRANE.
The individual crane's load chart, operating instructions and other instructional plates must be read and understood prior to operating the crane*

Working range

Working range diagram with bi-fold extension

(Boom deflection not shown)

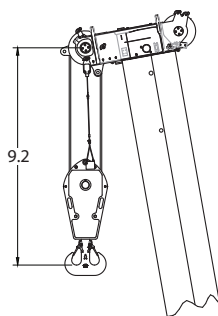
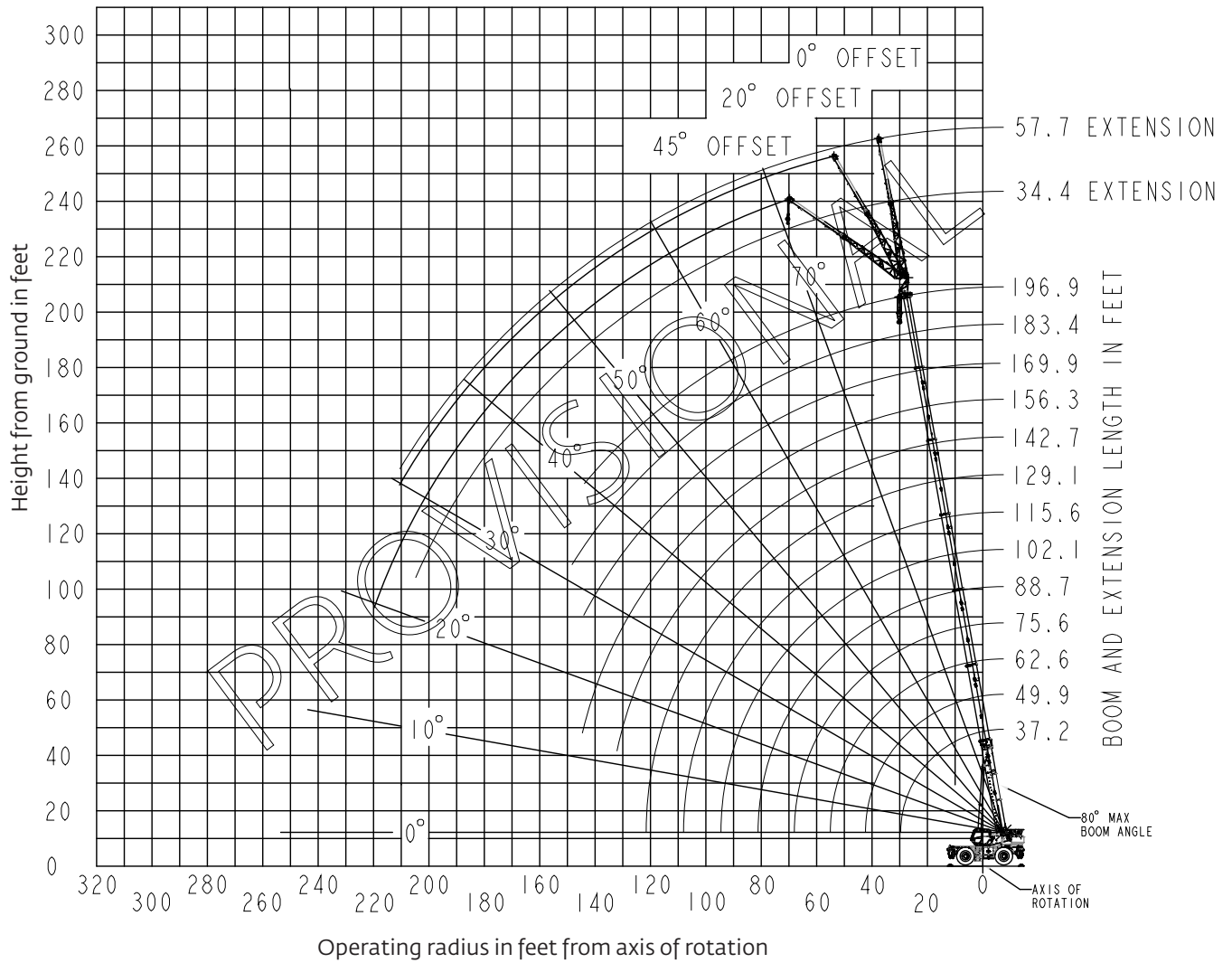

Dimension shown is for the largest Grove furnished hookblock with anti-two block activated.

*THIS CHART IS ONLY A GUIDE AND SHOULD NOT BE USED TO OPERATE THE CRANE.
The individual crane's load chart, operating instructions and other instructional plates must be read and understood prior to operating the crane*

Load chart

Main boom



37.2 ft - 197 ft



29,200 lb



100%



360°



Pounds

| Radius in feet | Main boom length in feet | | | | | | | | | | | | |
|----------------|--------------------------|-------------|-------------|-----------|-------------|------------|-------------|---------------|---------------|---------------|---------------|---------------|--|
| | 37.2 | 49.9 - 50.8 | 60.5 - 64.4 | 73.6 - 78 | 84.5 - 91.3 | 98 - 104.4 | 109.3 - 117 | 122.9 - 137.7 | 147.9 - 154.1 | 156.3 - 169.9 | 183.4 - 184.1 | 194.7 - 196.9 | |
| 8 | 240,000* | 180,000 | | | | | | | | | | | |
| 10 | 176,500 | 177,500 | 160,000 | | | | | | | | | | |
| 12 | 158,000 | 159,000 | 145,000 | 125,000 | | | | | | | | | |
| 15 | 136,000 | 137,000 | 129,500 | 114,000 | 100,500 | | | | | | | | |
| 20 | 105,500 | 106,500 | 105,500 | 95,700 | 85,750 | 80,250 | | | | | | | |
| 25 | 80,400 | 83,150 | 82,350 | 81,400 | 75,600 | 69,250 | 65,350 | | | | | | |
| 30 | | 65,100 | 66,150 | 65,950 | 64,800 | 62,800 | 58,700 | 53,500 | | | | | |
| 35 | | 53,350 | 53,650 | 53,500 | 55,000 | 54,850 | 52,950 | 48,950 | 36,600 | | | | |
| 40 | | 43,750 | 43,750 | 45,250 | 44,650 | 46,000 | 44,700 | 43,550 | 36,600 | 29,650 | | | |
| 45 | | | 37,200 | 37,200 | 37,200 | 37,800 | 36,550 | 35,450 | 35,950 | 29,350 | 21,200 | | |
| 50 | | | 31,050 | 31,250 | 32,650 | 31,900 | 31,450 | 29,650 | 30,200 | 29,350 | 21,200 | 17,900 | |
| 55 | | | 26,250 | 28,200 | 27,950 | 27,200 | 28,000 | 26,500 | 25,550 | 25,200 | 21,200 | 17,900 | |
| 60 | | | | 24,350 | 24,200 | 24,650 | 24,250 | 23,500 | 21,850 | 22,100 | 21,200 | 17,900 | |
| 65 | | | | 21,200 | 21,150 | 21,950 | 21,200 | 20,450 | 19,400 | 19,900 | 19,550 | 17,900 | |
| 70 | | | | 16,650 | 19,050 | 19,400 | 18,650 | 17,950 | 18,150 | 17,800 | 17,350 | 17,150 | |
| 75 | | | | | 17,500 | 17,300 | 16,650 | 16,000 | 16,350 | 16,400 | 15,350 | 15,300 | |
| 80 | | | | | 14,700 | 15,500 | 14,850 | 14,600 | 15,200 | 14,850 | 13,900 | 13,500 | |
| 85 | | | | | | 13,850 | 13,250 | 13,650 | 13,750 | 13,250 | 12,600 | 11,950 | |
| 90 | | | | | | 12,450 | 11,850 | 12,550 | 12,450 | 11,900 | 11,200 | 10,550 | |
| 95 | | | | | | 9,810 | 10,600 | 11,800 | 11,200 | 10,650 | 10,000 | 9,380 | |
| 100 | | | | | | | 9,520 | 10,700 | 10,150 | 10,000 | 8,950 | 8,310 | |
| 105 | | | | | | | 8,660 | 9,730 | 9,190 | 9,160 | 8,000 | 7,360 | |
| 110 | | | | | | | | 8,850 | 8,320 | 8,290 | 7,140 | 6,510 | |
| 115 | | | | | | | | 8,070 | 7,540 | 7,510 | 6,360 | 5,730 | |
| 120 | | | | | | | | 7,510 | 6,820 | 6,800 | 5,660 | 5,030 | |
| 125 | | | | | | | | 6,330 | 6,160 | 6,140 | 5,020 | 4,390 | |
| 130 | | | | | | | | 3,940 | 5,550 | 5,530 | 4,430 | 3,810 | |
| 135 | | | | | | | | | 5,000 | 4,970 | 3,890 | 3,270 | |
| 140 | | | | | | | | | 4,490 | 4,470 | 3,400 | 2,780 | |
| 145 | | | | | | | | | 4,030 | 4,000 | 2,930 | 2,330 | |
| 150 | | | | | | | | | | 3,090 | 2,490 | 1,900 | |
| 155 | | | | | | | | | | 2,700 | 2,090 | 1,500 | |
| 160 | | | | | | | | | | 2,330 | 1,710 | 1,120 | |
| 165 | | | | | | | | | | | 1,370 | | |
| 170 | | | | | | | | | | | 1,050 | | |

*Requires special equipment

THIS CHART IS ONLY A GUIDE AND SHOULD NOT BE USED TO OPERATE THE CRANE.
The individual crane's load chart, operating instructions and other instructional plates must be read and understood prior to operating the crane

Load chart

Main boom - MAXbase 20° over outriggers



37.2 ft - 197 ft



29,200 lb



100%



MAXbase



Pounds

| Radius in feet | Main boom length in feet | | | | | | | | | | | | |
|-------------------|--------------------------|-------------|-------------|-----------|-------------|------------|-------------|---------------|---------------|---------------|---------------|---------------|--|
| | 37.2 | 49.9 - 50.8 | 60.5 - 64.4 | 73.6 - 78 | 84.5 - 91.3 | 98 - 104.4 | 109.3 - 117 | 122.9 - 137.7 | 147.9 - 154.1 | 156.3 - 169.9 | 183.4 - 184.1 | 194.7 - 196.9 | |
| 8 | 180,000 | | | | | | | | | | | | |
| 10 | 176,500 | 177,500 | 160,000 | | | | | | | | | | |
| 12 | 158,000 | 159,000 | 145,000 | 125,000 | | | | | | | | | |
| 15 | 136,000 | 137,000 | 129,500 | 114,000 | 100,500 | | | | | | | | |
| 20 | 105,000 | 105,500 | 105,000 | 95,700 | 85,750 | 80,250 | | | | | | | |
| 25 | 80,950 | 83,550 | 82,600 | 81,400 | 75,600 | 69,250 | 65,350 | | | | | | |
| 30 | | 65,500 | 66,450 | 66,100 | 64,900 | 62,800 | 58,700 | 53,500 | | | | | |
| 35 | | 53,350 | 53,950 | 53,750 | 55,150 | 54,850 | 52,950 | 48,950 | 36,600 | | | | |
| 40 | | 44,550 | 44,800 | 45,250 | 46,150 | 47,400 | 46,250 | 43,850 | 36,600 | 29,350 | | | |
| 45 | | | 39,200 | 39,550 | 39,150 | 40,550 | 39,400 | 38,450 | 35,800 | 29,350 | 21,200 | | |
| 50 | | | 33,650 | 34,050 | 33,750 | 35,050 | 34,050 | 33,100 | 32,750 | 29,200 | 21,200 | 17,900 | |
| 55 | | | 29,200 | 29,600 | 30,900 | 30,600 | 29,600 | 28,750 | 29,250 | 27,250 | 21,200 | 17,900 | |
| 60 | | | | 26,000 | 27,450 | 26,900 | 27,300 | 25,150 | 25,700 | 25,150 | 21,200 | 17,450 | |
| 65 | | | | 24,100 | 24,350 | 23,850 | 24,750 | 22,200 | 22,700 | 22,150 | 20,850 | 16,650 | |
| 70 | | | | 18,350 | 21,750 | 21,650 | 22,100 | 20,450 | 20,150 | 19,750 | 19,650 | 15,900 | |
| 75 | | | | | 19,450 | 20,400 | 19,850 | 18,900 | 17,900 | 18,050 | 18,550 | 15,150 | |
| 80 | | | | | 17,500 | 18,450 | 17,900 | 17,300 | 16,000 | 17,000 | 16,800 | 14,400 | |
| 85 | | | | | | 16,750 | 16,150 | 15,600 | 15,050 | 15,300 | 15,100 | 13,550 | |
| 90 | | | | | | 15,200 | 14,650 | 14,050 | 14,150 | 13,750 | 13,600 | 12,700 | |
| 95 | | | | | | 12,400 | 13,250 | 12,700 | 13,150 | 12,400 | 12,250 | 11,900 | |
| 100 | | | | | | | 12,050 | 11,450 | 11,950 | 11,250 | 11,000 | 11,100 | |
| 105 | | | | | | | 10,950 | 10,800 | 10,950 | 10,500 | 9,950 | 10,100 | |
| 110 | | | | | | | | 10,250 | 10,300 | 9,800 | 8,970 | 9,120 | |
| 115 | | | | | | | | 9,740 | 9,720 | 9,150 | 8,360 | 8,200 | |
| 120 | | | | | | | | 8,970 | 8,890 | 8,450 | 7,800 | 7,360 | |
| 125 | | | | | | | | 8,210 | 8,330 | 7,840 | 7,250 | 6,600 | |
| 130 | | | | | | | | 4,900 | 7,630 | 7,140 | 6,550 | 5,910 | |
| 135 | | | | | | | | | 6,980 | 6,490 | 5,910 | 5,280 | |
| 140 | | | | | | | | | 6,380 | 6,080 | 5,310 | 4,690 | |
| 145 | | | | | | | | | 5,820 | 5,730 | 4,750 | 4,150 | |
| 150 | | | | | | | | | | 4,810 | 4,230 | 3,630 | |
| 155 | | | | | | | | | | 4,320 | 3,740 | 3,140 | |
| 160 | | | | | | | | | | 3,530 | 3,280 | 2,690 | |
| 165 | | | | | | | | | | | 2,860 | 2,260 | |
| 170 | | | | | | | | | | | 2,450 | 1,860 | |
| 175 | | | | | | | | | | | 2,070 | 1,480 | |
| 180 | | | | | | | | | | | | 1,120 | |

THIS CHART IS ONLY A GUIDE AND SHOULD NOT BE USED TO OPERATE THE CRANE.

The individual crane's load chart, operating instructions and other instructional plates must be read and understood prior to operating the crane

Load chart

Manual bi-fold extension



37.2 ft - 197 ft



35 ft



29,200 lb



100%



360°



Pounds

| Radius in feet | 35 ft boom extension | | | | | | | | |
|----------------|------------------------------|------------|------------|------------------------------|------------|------------|------------------------------|------------|------------|
| | 167.7 - 169.9 ft boom length | | | 183.4 - 184.1 ft boom length | | | 194.7 - 196.9 ft boom length | | |
| | 0° offset | 20° offset | 45° offset | 0° offset | 20° offset | 45° offset | 0° offset | 20° offset | 45° offset |
| 40 | 12,500 | | | | | | | | |
| 45 | 12,500 | | | 11,300 | | | | | |
| 50 | 12,500 | | | 11,300 | | | 9,780 | | |
| 55 | 12,500 | 13,050 | | 11,300 | | | 9,780 | | |
| 60 | 12,500 | 13,050 | | 11,300 | 11,700 | | 9,780 | | |
| 65 | 12,500 | 13,050 | 11,350 | 11,300 | 11,700 | | 9,780 | 10,050 | |
| 70 | 12,500 | 13,050 | 11,150 | 11,300 | 11,700 | 11,300 | 9,780 | 10,050 | |
| 75 | 12,500 | 12,300 | 10,950 | 11,300 | 11,700 | 11,100 | 9,780 | 10,050 | 10,550 |
| 80 | 11,650 | 11,600 | 10,750 | 11,300 | 11,700 | 10,900 | 9,780 | 10,050 | 10,550 |
| 85 | 10,800 | 10,900 | 10,600 | 11,050 | 11,700 | 10,750 | 9,780 | 10,050 | 10,550 |
| 90 | 10,050 | 10,200 | 10,400 | 10,300 | 10,700 | 10,600 | 9,730 | 10,050 | 10,550 |
| 95 | 9,380 | 9,530 | 9,800 | 9,210 | 9,910 | 10,250 | 8,550 | 9,410 | 10,150 |
| 100 | 8,740 | 8,900 | 9,230 | 8,160 | 8,900 | 9,530 | 7,500 | 8,300 | 8,990 |
| 105 | 7,920 | 8,310 | 8,620 | 7,220 | 7,900 | 8,470 | 6,560 | 7,310 | 7,940 |
| 110 | 7,070 | 7,630 | 8,050 | 6,370 | 7,010 | 7,520 | 5,720 | 6,410 | 6,990 |
| 115 | 6,300 | 6,820 | 7,210 | 5,610 | 6,200 | 6,660 | 4,970 | 5,610 | 6,130 |
| 120 | 5,610 | 6,090 | 6,430 | 4,920 | 5,460 | 5,880 | 4,280 | 4,880 | 5,350 |
| 125 | 4,970 | 5,410 | 5,710 | 4,290 | 4,790 | 5,170 | 3,650 | 4,210 | 4,630 |
| 130 | 4,390 | 4,800 | 5,060 | 3,710 | 4,180 | 4,510 | 3,080 | 3,600 | 3,980 |
| 135 | 3,860 | 4,230 | 4,450 | 3,190 | 3,620 | 3,910 | 2,550 | 3,040 | 3,380 |
| 140 | 3,370 | 3,710 | 3,890 | 2,700 | 3,100 | 3,350 | 2,070 | 2,520 | 2,820 |
| 145 | 2,920 | 3,230 | | 2,250 | 2,620 | 2,840 | 1,620 | 2,040 | 2,310 |
| 150 | 2,510 | 2,780 | | 1,840 | 2,170 | 2,360 | 1,210 | 1,590 | 1,830 |
| 155 | 2,120 | 2,370 | | 1,450 | 1,760 | | | 1,180 | 1,380 |
| 160 | 1,760 | 1,980 | | 1,090 | 1,370 | | | | |
| 165 | 1,430 | 1,620 | | | 1,010 | | | | |
| 170 | 1,120 | 1,280 | | | | | | | |

THIS CHART IS ONLY A GUIDE AND SHOULD NOT BE USED TO OPERATE THE CRANE.

The individual crane's load chart, operating instructions and other instructional plates must be read and understood prior to operating the crane

Load chart

Manual bi-fold extension

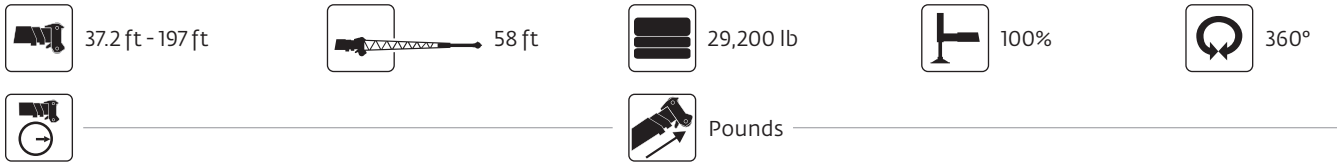

| Radius in feet | 58 ft boom extension | | | | | | | | |
|----------------|------------------------------|------------|------------|------------------------------|------------|------------|------------------------------|------------|------------|
| | 167.7 - 169.9 ft boom length | | | 183.4 - 184.1 ft boom length | | | 194.7 - 196.9 ft boom length | | |
| | 0° offset | 20° offset | 45° offset | 0° offset | 20° offset | 45° offset | 0° offset | 20° offset | 45° offset |
| 45 | 7,590 | | | | | | | | |
| 50 | 7,590 | | | 7,110 | | | | | |
| 55 | 7,590 | | | 7,110 | | | 6,280 | | |
| 60 | 7,590 | | | 7,110 | | | 6,280 | | |
| 65 | 7,590 | | | 7,110 | | | 6,280 | | |
| 70 | 7,590 | 7,290 | | 7,110 | | | 6,280 | | |
| 75 | 7,590 | 7,130 | | 7,110 | 7,200 | | 6,280 | | |
| 80 | 7,590 | 6,980 | 5,680 | 7,110 | 7,060 | | 6,280 | 6,990 | |
| 85 | 7,590 | 6,830 | 5,620 | 7,110 | 6,920 | 5,650 | 6,280 | 6,860 | |
| 90 | 7,590 | 6,700 | 5,560 | 7,110 | 6,790 | 5,590 | 6,280 | 6,740 | |
| 95 | 7,590 | 6,560 | 5,500 | 7,110 | 6,660 | 5,530 | 6,280 | 6,620 | 5,530 |
| 100 | 7,590 | 6,440 | 5,440 | 7,110 | 6,540 | 5,480 | 6,280 | 6,510 | 5,480 |
| 105 | 7,590 | 6,320 | 5,390 | 7,030 | 6,420 | 5,430 | 6,280 | 6,410 | 5,430 |
| 110 | 7,180 | 6,210 | 5,340 | 6,780 | 6,310 | 5,380 | 6,140 | 6,300 | 5,390 |
| 115 | 6,710 | 6,100 | 5,290 | 6,010 | 6,210 | 5,330 | 5,380 | 6,200 | 5,340 |
| 120 | 6,000 | 6,000 | 5,260 | 5,310 | 6,070 | 5,290 | 4,680 | 5,800 | 5,300 |
| 125 | 5,360 | 5,900 | 5,220 | 4,680 | 5,640 | 5,260 | 4,050 | 5,100 | 5,270 |
| 130 | 4,780 | 5,580 | 5,200 | 4,090 | 5,000 | 5,230 | 3,470 | 4,450 | 5,230 |
| 135 | 4,240 | 4,990 | 5,150 | 3,560 | 4,400 | 5,130 | 2,930 | 3,860 | 4,670 |
| 140 | 3,740 | 4,440 | 5,000 | 3,060 | 3,860 | 4,520 | 2,440 | 3,320 | 4,060 |
| 145 | 3,280 | 3,930 | 4,430 | 2,610 | 3,350 | 3,950 | 1,990 | 2,810 | 3,490 |
| 150 | 2,860 | 3,460 | 3,900 | 2,190 | 2,880 | 3,420 | 1,570 | 2,340 | 2,960 |
| 155 | 2,470 | 3,030 | 3,410 | 1,800 | 2,440 | 2,930 | 1,180 | 1,900 | 2,470 |
| 160 | 2,100 | 2,620 | 2,940 | 1,430 | 2,040 | 2,470 | | 1,500 | 2,010 |
| 165 | 1,760 | 2,230 | 2,510 | 1,090 | 1,650 | 2,040 | | 1,110 | 1,570 |
| 170 | 1,440 | 1,870 | | | 1,300 | 1,630 | | | 1,170 |
| 175 | 1,150 | 1,540 | | | | 1,240 | | | |
| 180 | | 1,220 | | | | | | | |

THIS CHART IS ONLY A GUIDE AND SHOULD NOT BE USED TO OPERATE THE CRANE.
 The individual crane's load chart, operating instructions and other instructional plates must be read and understood prior to operating the crane

Load handling

| Weight reductions for load handling devices | |
|---|--------------------|
| Auxiliary boom nose | 88 kg (194 lb) |
| Hook blocks and overhaul weights: | |
| 100 t (112 USt), 7-sheave | 1140 kg (2513 lb)+ |
| 75 t (83 USt), 5-sheave | 1070 kg (2359 lb)+ |
| 45 t (50 USt), 3-sheave | 770 kg (1698 lb)+ |
| 26 t (29 USt), single sheave | 535 kg (1179 lb)+ |
| 11 t (12 USt), overhaul weight | 294 kg (648 lb)+ |
| 9 t (10 USt), overhaul ball | 330 kg (727 lb)+ |

*Refer to rating plate for actual weight.

| Line pulls and reeving information | | | |
|------------------------------------|---|------------------------|----------------------|
| Hoists | Cable specs. | Permissible line pulls | Nominal cable length |
| Main | 19 mm (3/4 in) 35x7 Class rotation resistant (non-rotating) Min. breaking strength 38 918 kg (85,800 lb) | 7784 kg (17,160 lb)* | 250 m (820 ft) |
| Auxiliary | 19 mm (3/4 in) 35x7 Class rotation resistant (non-rotating) Min. breaking strength 38 918 kg (85,800 lb) | 7784 kg (17,160 lb)* | 185 m (607 ft) |

The approximate weight of 19 mm (3/4 in) wire rope is 2.2 kg/m (1.5 lb/ft).

*With certain boom and hoist tackle combinations, the allowable line pull may be limited by hoist performance. Refer to Hoist performance table for lift planning to ensure adequate hoist performance on drum rope layer required.

| Hoist performance | | | | |
|-------------------|------------------|--------------|--------------------|-------|
| Wire rope layer | Hoist line pulls | | Drum capacity (ft) | |
| | Two speed hoist | | Layer | Total |
| | Low | High | | |
| | Available lb | Available lb | | |
| 1 | 23,468 | 12,957 | 108.7 | 108.7 |
| 2 | 21,553 | 11,900 | 118.4 | 227.1 |
| 3 | 19,927 | 11,003 | 128.1 | 355.2 |
| 4 | 18,530 | 10,231 | 137.7 | 492.9 |
| 5 | 17,315 | 9560 | 147.4 | 640.3 |
| 6 | 16,250 | 8972 | 157.1 | 797.4 |

*Refer to Line Pulls and Reeving Information table for max. lifting capacity of wire rope.

Synthetic rope layer height may vary and may reduce available line pull per layer.

| Tire inflation | | |
|-----------------------|----------|---|
| Size (front and rear) | TRA Code | Lifting service, general travel and extended travel |
| | | Static, creep and 2.5 mph (4.0 km/h) |
| 29.5 x 25 - 34 PR | E-3 | 5.2 bar (76 psi) |

Working area diagram

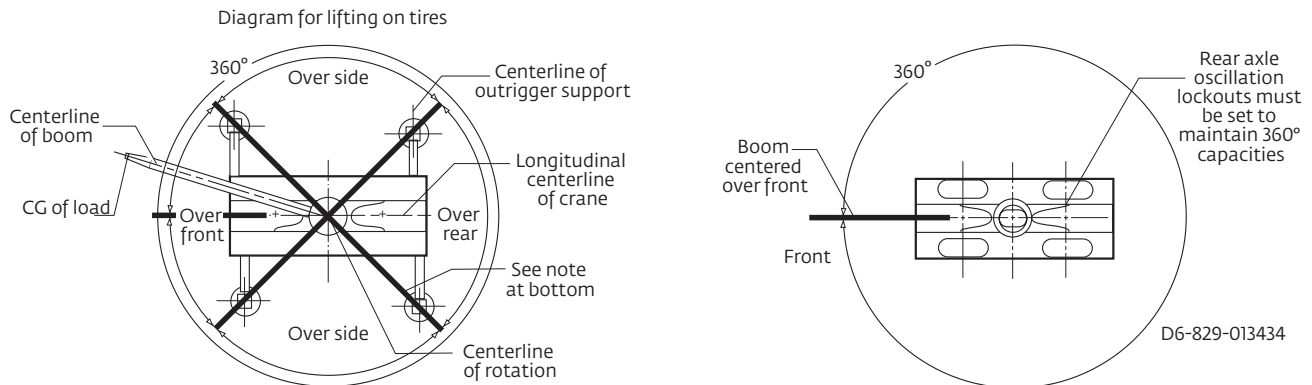

Bold lines determine the limiting position of any load for operation within working areas indicated.

THIS CHART IS ONLY A GUIDE AND SHOULD NOT BE USED TO OPERATE THE CRANE.

The individual crane's load chart, operating instructions and other instructional plates must be read and understood prior to operating the crane

Superstructure

Boom

BOOM: 11,3 m - 60 m (37.2 ft - 197 ft) seven-section MEGAFORM™ boom with TWIN-LOCK™ boom pinning system.
Maximum tip height: 63.1 m (207 ft)

Boom nose

Five nylon sheaves mounted on heavy-duty tapered roller bearings with removable pin type guards. Quick reeve boom nose. Removable single sheave auxiliary boom nose with removable pin-type rope guard.

Boom elevation

Single hydraulic cylinder with integral holding valve provides boom elevation from -3° to +80°.

Manual bi-fold swingaway extension*

10,5 m - 17,6 m (34.5 ft - 57.6 ft) bi-fold lattice swingaway extension. Offsets at 0°, 20° and 45°. Stows alongside base boom section. Includes wireless rigging remote.
Maximum tip height: 80.8 m (265 ft)

Hydraulic bi-fold swingaway extension*

10,5 m - 17,6 m (34.5 ft - 57.6 ft) bi-fold lattice swingaway extension. Hydraulically offsets from 0° to 45°. Controlled from crane cab. Stows alongside base boom section. Includes wireless rigging remote.
Maximum tip height: 80.8 m (265 ft)

Crane Control System (CCS)

Rated Capacity Limiter (RCL) with graphical display. Load moment and anti-two block system with audio-visual warning and control lever lockout. This system provides electronic display of boom angle, boom length, load radius, boom tip height, maximum permissible load, actual load and warning of impending two-block condition. Also includes an Operating display which shows the crane operating indicators, levels, warnings and faults. Other features include a Working Range Limiter (WRL) which allows the operator to preselect and define working areas. If the crane approaches the operator preset limits, audio-visual warnings aid the operator in avoiding obstructions. ECO mode system to control engine rpm to lower noise and improve fuel consumption. Operator-programmable function speeds and ramps.

Cab

Operator-controlled 20° hydraulic cab tilt, full vision, all steel fabricated with acoustical lining and tinted safety glass throughout. Deluxe seat with headrest, incorporates armrest-mounted electronic programmable single-axis or dual-axis controllers and a jog dial for easy data input. Tilt/telescoping steering wheel with controls incorporated into the steering column. Other standard features include heater (hot water), circulating air fan, high-output air conditioning system, sliding skylight with sunscreen, windshield and skylight washer/wiper, windshield sun visor, fire extinguisher, seat belt, USB charging port, pivoting cup holder, and dual cab-mounted work lights.

* Denotes optional equipment

Swing

Variable speed, 360° continuous rotation. Planetary swing drive with foot actuated multi-disc brake. Spring-applied, hydraulically released swing brake. Two-position mechanical swing lock pin, operated from cab.
Maximum speed: 2 rpm

Counterweight

13 245 kg (29,200 lb) hydraulically installed and removed. Controlled via CCS operating display in cab or via wireless rigging remote.

Hoist (main and optional auxiliary hoist)

Planetary reduction driven by axial piston motor. Grooved drum with automatic spring applied multi-disc wet brake. Electronic hoist drum rotation indicator. Third wrap indicator with hoist function cut-out standard.

Maximum hoist single line pull:

1st layer: 10 645 kg (23,468 lb)

3rd layer: 9039 kg (19,927 lb)

6th layer: 7371 kg (16,250 lb)

Maximum permissible single line pull:

7784 kg (17,160 lb)

Maximum hoist single line speed (no load):

148 m/min (487 ft/min)

Rope construction:

35 x 7 rotation – resistant

Rope diameter:

19 mm (3/4 in)

Rope length:

Main hoist: 250 m (820 ft)

Auxiliary hoist: 185 m (607 ft)

Carrier

Chassis

Parallel box section fabricated from high-strength, low-alloy steel with integral outrigger boxes, front and rear lift, tie-down, and towing lugs.

Outrigger system

Four hydraulic telescoping single stage double box beam outriggers with inverted jack cylinders and integral jack holding valves. Three position settings, 0%, 50%, and fully extended. Polymer outrigger floats 600 mm (23.6 in) diameter. Outrigger Monitoring System (OMS) with in-cylinder sensors. Outrigger beam position shown on RCL display.

Outrigger controls

Main controls and digital level shown on operating display in cab. Extension and retraction are through the CCS system as well as the wireless rigging remote. Includes automatic leveling feature.

Specifications

Carrier *cont'd*



Hydraulic system

Two main pumps variable displacement piston and one gear with a combined output capacity of 507 L/min (134 gal/min).
Maximum operating pressure: 276 bar (4000 psi)
Return line in-tank filter with full flow by-pass protection and service indicator.
Replaceable cartridge with 4 micron filtration rating per ISO cleanliness level of 17/15/12. Carrier mounted oil cooler with thermostatically controlled hydraulic motor driven fan / air to oil. System pressure test ports.



Engine (Tier 4F)

Cummins QSB6, 7L diesel six cylinder, turbo-charged with Cummins Compact Catalyst (CCC) and selective catalytic reduction (SCR) combo muffler, using diesel exhaust fluid (DEF) injection. Meets emissions per U.S. EPA Tier 4F and E.U. Stage IV.
275 hp (205 kW) at 2500 rpm, Maximum torque: 730 lb/ft (990 Nm) at 1500 rpm. Fuel requirements: Maximum of 15 ppm ultra-low sulfur diesel fuel + diesel exhaust fluid (DEF).



Engine (Tier 3)

Cummins QSB6, 7L diesel six cylinder, turbo-charged with 275 hp (205 kW) at 2500 rpm, Maximum torque: 730 lb/ft (990 Nm) at 1500 rpm. Fuel requirements: Maximum of 5000 ppm. Sulfur diesel fuel.



Fuel tank capacity

312 L (82 gal)



Transmission

Rangeshift with six forward and six reverse speeds.
(Three speeds high and three speeds low). Front axle disconnect for 4 x 2 drive.



Axles

FRONT: Drive / steer with differential and planetary reduction hubs rigid mounted to frame.
REAR: Drive / steer with differential and planetary reduction hubs pivot mounted to frame. Automatic full hydraulic lockouts on rear axle permits 254 mm (10 in) of oscillation only with boom centered over the front.



Brakes

Full hydraulic split (dual) circuit dry disc operating on all wheels with dual calipers. High pressure parking brake is spring applied / hydraulically released on the front axle input shaft.



Steering

Fully independent power steering.
Front: Fully hydraulic steering wheel controlled.
Rear: Fully hydraulic via separate momentary switch provides infinite variations 4 steering modes, front only, rear only, coordinated and crab.
Rear steer not aligned indicator.
Outside 4WS coordinated steer radius: 7,5 m (24.6 ft)
Inside 4WS coordinated steer radius: 4,8 m (15.8 ft)



Tires

29.5 x 25 – 34 bias ply rating



Electrical system

Two 12 V maintenance-free batteries with disconnect.
24 V system / 24 V lighting



Lighting

Full LED lighting package including turn indicators; head, tail, brake and hazard warning lights; carrier side mounted work lights and work lights mounted on cab front.



Maximum Drive Speed

24,1 km/h (15 mph) with counterweight installed.



Gradeability (theoretical)

70% to drive train stall based on 58 917 kg (129,889 lb) GVW with 29.5 x 25 tires, standard counterweight, auxiliary hoist and manual bi-fold extension.

Miscellaneous standard equipment



























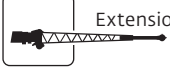

Full length aluminum decking, dual rear view mirrors, hook block tie-down, electronic back-up alarm, covered deck storage compartment, hot water cab heater / defroster, cab air conditioner, hoist mirrors, hourmeter, A/V warning system, combination lift/tie-down/towing lugs, coolant sight level indicator, hoist access platform, storage boxes on both sides of carrier and cribbing storage on left side of carrier.

*Optional equipment

- Auxiliary Hoist Package: Includes auxiliary hoist with electronic hoist drum rotation indicator, hoist drum cable follower, third wrap indicator with hoist function cut-out, 185 m (607 ft) of 19 mm (¾ in.) of 35 x 7 class rotation resistant wire rope.
- Auxiliary Lighting and Convenience Package: Includes superstructure mounted amber flashing beacon, dual base boom mounted LED work lights controlled from cab and in-cab RCL light bar.
- 10,5 m - 17,6 m (34.5 ft - 57.6 ft) manual bi-fold swingaway extension
- 10,5 m - 17,6 m (34.5 ft - 57.6 ft) hydraulic luffing extension
- 360° NYC style mechanical swing lock
- Rear pintle hitch
- Cab-controlled cross axle differential locks (front and rear)
- Wind speed indicator
- Vertical RCL light tower
- -29C / -20F cold weather package
- -40C / -40F arctic weather package
- Emergency stop buttons on each side of carrier
- Second beacon light
- Refinery package (certified spark arrestor + engine air shutdown) (T3 engine only)
- MAXbase - variable outrigger positioning system
- Three camera package (rear-view, right side and hoists)
- Bluetooth/AM/FM radio
- Heated seat
- CraneSTAR asset management system

* Denotes optional equipment

Symbols glossary

| | | | | | | | |
|---|----------------|---|----------------------|---|--------------------|--|--------------|
|  | Axles |  | Counterweight |  | Hydraulic system |  | Speed |
|  | Boom |  | Crane control system |  | Insert |  | Steering |
|  | Boom elevation |  | Electrical system |  | Lights |  | Suspension |
|  | Boom extension |  | Engine |  | MAXbase |  | Swing |
|  | Boom nose |  | Extension |  | Outrigger controls |  | Tires |
|  | Brakes |  | Fuel tank capacity |  | Outriggers |  | Transmission |
|  | Cab |  | Grade |  | Radius | | |
|  | Chassis |  | Hoist |  | Rotation | | |

Manitowoc Cranes

Regional headquarters

Americas

Milwaukee, Wisconsin, USA

Tel: +1 414 760 4600

Shady Grove, Pennsylvania, USA

Tel: +1 717 597 8121

Europe and Africa

Dardilly, France - TOWERS

Tel: +33 (0) 4 72 18 20 20

Wilhelmshaven, Germany - MOBILE

Tel: +49 (0) 4421 294 0

APAC

Shanghai, China

Tel: +86 21 6457 0066

Singapore

Tel: +65 6264 1188

Middle East and India

Dubai, UAE

Tel: +971 4 8862677



This document is non-contractual. Constant improvement and engineering progress make it necessary that we reserve the right to make specification, equipment, and price changes without notice. Illustrations shown may include optional equipment and accessories and may not include all standard equipment.