



164 kW (Stage IIIa)

186 kW (Stage V)



120 t



40 m



MAXCAB

6113E

Telescopic crawler crane

6113E Advanced. The E-Series.



TX10 telescopic crane

What makes up the E-Series

- Over 25 years of experience in construction and building of highly specialized telescopic cranes
- Uncompromisingly high performance in all areas
- Technology that can be mastered: High-quality components without over-engineering
- Long service life and high value stability

Your top benefits:

1

Green Efficiency

Save fuel – reduce operating costs

Work quietly – protect operator and environment



2

Peak performance

Robust boom system – work on an incline of up to 4°

2 equivalent crane winches - high rope speed

3

Maximum usability

Comfortable Maxcab operator cab - relaxed work

SENCON - work program selection made easy



4

Flexibility in service

Operate under full load – less space required

Strong undercarriage traction – good off-road capability

5

Easy transport

Mobile undercarriage with outrigger – ready to go in no time

6

Maintenance and service made easy

SENNEBOGEN control system – easy error diagnostics

Simple maintenance – clear labeling

7

Consultation and support in your area

3 production sites – 2 subsidiaries

130 sales partners – over 350 service stations



Stage V

- Modern, powerful engine
- Fuel-efficient
- Low emissions

6113E Powerful. Effective.

Strong telescopic boom for demanding tasks

- Maintenance-free telescoping thanks to multi-cylinder system
Maintenance-free cable drive or chain drive
- Work on inclines of up to 4° possible*
- Telescoping under load
- Full power boom

Large operating range

- 40.2 m boom length
- Extendable up to 67 m with fly boom and tower extension

Easy and flexible work – saves time

- Precision hydraulics allow telescoping to any boom length quickly
- Intuitive joystick control
- Ready to go in no time, even with varying work heights
- Always the ideal boom length in no time at all

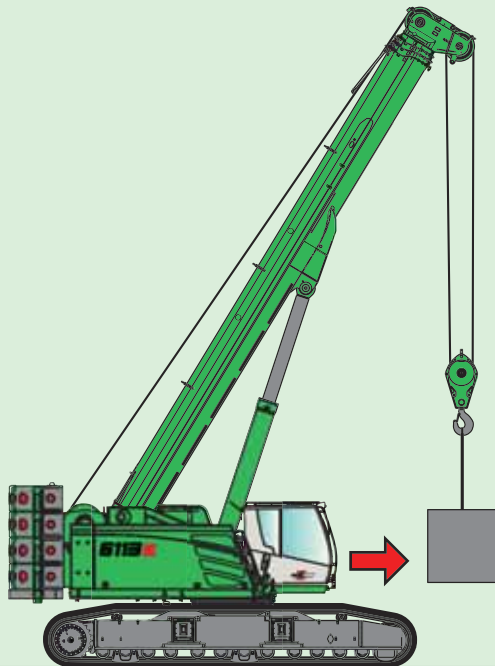

Unique flexibility on the construction site

- Moveable even under high loads
- Excellent maneuverability thanks to strong undercarriage traction
- Easy, inexpensive transport and short set-up time thanks to self-assembly system

Telescopic undercarriage

- Maximum stability due to long, telescopic crawler track with large outrigger area
- Low ground pressure due to wide crawler shoes, wvreliable stability even during dynamic tasks
- Robust tractor chassis and well sized travel drive for maximum all-terrain movement

6113E Modern. Flexible.



Hoisting winches

- Two hoisting winches working side by side
- Compact machine with small rear radius



Quiet operation

- Consistently quiet operation thanks to decoupled engine suspension and soundproofing

Clearly arranged engine compartment

- Extremely service-friendly design
- Engine Stage IIIa emission standard
- Engine Stage V emission standard incl. AdBlue supply



The premium cab.

Panoramic view

Features

- optimum cab climate with automatic air conditioning system, partial tinted glass
- pleasant and equal temperature dispersion by means of 9 nozzles
- panoramic view
- climatic comfort seat with air suspension and air conditioning*
- very quiet through optimized noise insulation
- Highest safety & comfort with sliding door, wide door opening
- ergonomically arranged operating controls for fatigue-free and relaxed working
- 12 V, 24 V, and USB charging sockets hands-free telephone preparation, document box
- various options: electric cooler behind's, protective covers, seat air conditioning

Our SENNEBOGEN joysticks

- consoles and ergonomic joysticks that move with the seat
- pleasant grip through ergonomic design
- precise control of all movements through direct and sensitive function activation
- quick access to all operating controls through optimized design of all push-buttons and switches

6113E Maintenance and service made easy

Simplest service

- Central, easily accessible lubricating strip
- Optional: central lubrication system for automatic lubrication

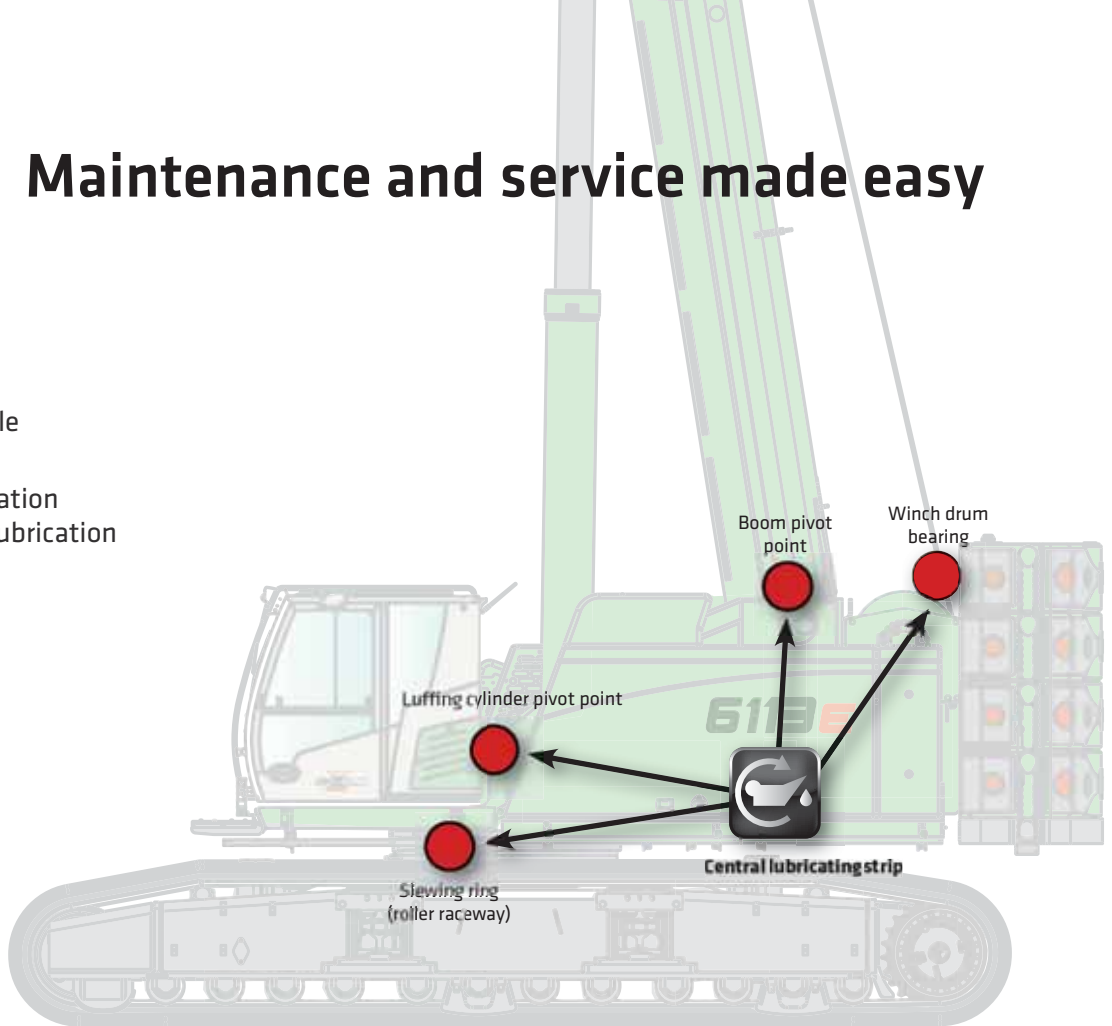

HydroClean*

- Optimal protection of hydraulic components thanks to 3 µm micro-filter
- Cleaner hydraulic oil, extended oil service life
- With water separator



Walkways on both sides

- Step grid in front of and next to cab for more safety while entering and exiting
- Step grids along left and right sides of uppercarriage for safe maintenance



Optimized for maintenance

- Fast and easy troubleshooting thanks to straightforward and clearly labeled electrical distributor
- Easy access to all service points on the machine

* Optional

6113E Technical data - equipment

MACHINE TYPE

Model (type) **6113**

ENGINE

Model	Cummins diesel engine B 6.7 186 kW / 253 hp at 2,000 rpm Compliant with Stage V emission standard
	Cummins diesel engine QSB 6.7 164 kW / 223 hp at 2,000 rpm Compliant with Stage IIIa emission standard
	Direct injection, turbo-charged, charge air cooling, reduced emissions
Cooling	Water-cooled
Diesel filter	with water separator and heating system
Air filter	Dry filter with integrated pre-separator, automatic dust discharge, main element and safety element, contamination indicator
Fuel tank	540 l
AdBlue tank	38 l
Electrical system	24 V
Batteries	2 x 155 AH battery disconnect switch
Options	<ul style="list-style-type: none"> ■ Low-temperature package with engine pre-heating and heated diesel filter for temperatures below -20 °C ■ Electric fuel pump

UPPERCARRIAGE

Design	Torsion-resistant box design, precision crafted, steel bushings for boom bearings Extremely service-friendly design, longitudinal engine
Electrical	Central electrical distributor, battery disconnect switch
Cooling system	3-circuit cooling system with high cooling capacity, thermostatically regulated fan drive for oil cooler, electronically regulated water and charge air cooler
Safety	Rearview and right sideview cameras LED lighting package Uppercarriage railing
Options	<ul style="list-style-type: none"> ■ Additional LED headlights ■ Up to 2 additional cameras ■ Anti-corrosive maritime climate varnish ■ Low-temperature package for use at temperatures below -20 °C

Options

- Automatic central lubrication for boom pivot point, luffing cylinder, slewing ring track and winch drum bearing
- Pinion tooth lubrication for slewing ring

HYDRAULIC SYSTEM

	Load sensing/LUDV hydraulic system, electrohydraulic pilot-controlled work functions, load limit sensing control
Pump type	Swashplate-type variable-displacement piston pump, load pressure-independent flow distribution for simultaneous, independent control of work functions
Pump control	Zero-stroke control, on-demand flow control - the pumps only pump as much oil as will actually be used, pressure purging, load limit sensing control
Operating pressure	Max. 330 bar
Filtration	High-performance filtration with long change interval
Hydraulic tank	1,125 l
Control system	Proportional, precision electrohydraulic actuation of work movements, 2 electric servo joysticks for work functions, including winch motion display via vibration transducer, additional functions via switches and pedals
Safety	Hydraulic circuits with safety valves Pipe fracture safety valve for luffing and telescoping cylinders
Options	<ul style="list-style-type: none"> ■ Bio-oil ■ SENNEBOGEN HydroClean 3 µm hydraulic microfilter ■ Electric heater for hydraulic tank for temperatures below -20 °C

SLEWING DRIVE

Gearbox	2x compact planetary gear with slant axis hydraulic motor, integrated brake valves
Slewing brake	Spring-loaded disk brake, pedal for individual braking
Slewing ring	Externally geared slewing ring, sealed
Slewing speed	0-2 rpm , continuous

6113E Technical data - equipment

CAB 	
Cab type	Maxcab full-size cab, 20° tiltable
Cab equipment	Sliding door, sliding window in the driver door, excellent ergonomics, automatic climate control, heated seat, air-suspension comfort seat, fresh air filter/circulating air filter, 12/24 V connections, SENCON, roller shade for sunroof
Options	<ul style="list-style-type: none"> ■ Hydraulically elevating cab E270, can be elevated 2.70 m and tilted 30° ■ Auxiliary heating system with timer ■ Activated-carbon filter for cab ■ Armored-glass windshield ■ FOPS protective roof grating ■ Radio with USB and SD connection, MP3, and Bluetooth function ■ Working range restriction

ATTACHMENTS	
Design	Decades of experience, state-of-the-art computer simulation, maximum stability, longest service life, oversized, low-maintenance bearing points, sealed special bearing bushes, precision-crafted
Telescopic boom	4-piece with roller head, continuous hydraulic telescoping from 12.6 – 40.2 m
Hoisting winch	Slant-axis hydraulic motor drive with compact planetary gear, 125 kN pulling power, 0 – 115 m/min. winching speed, 26 mm cable diameter, 175 m cable length. Winch motion display via vibration transducers in the joysticks
Safety brake	Spring-loaded disk brake
Crane safety	Latest generation of load moment monitoring, clearly organized panel displaying all important data via SENCON display, lifting limit switch, cable exit protection, pressure relief valves and pipe fracture safety device with event recorder
Cylinders	Hydraulic cylinders with high-quality sealing and guide elements
Options	<ul style="list-style-type: none"> ■ 8-m fly jib, tiltable (0°, 20°, 40°), extremely fast and easy setup without auxiliary devices, locked on basic boom when not in use ■ Fly jib extension to 15 m (7 m extension), tiltable (0°, 20°, 40°), must be transported separately

Options	<ul style="list-style-type: none"> ■ Auxiliary jib, 12-t load capacity, 1-strand ■ 2nd crane winch with 125 kN pulling power, 0–115 m/min. cable speed, 26 mm cable diameter, 175 m cable length ■ Additional load charts accepted for 2°/4° incline position ■ 3 kW electrohydraulic emergency unit ■ Remote radio control
---------	--

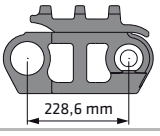
UNDERCARRIAGE	
Design	T119/540 crawler undercarriage with hydraulically extendable track gauge. Stable welded construction
Drive	Hydraulic travel drive per chassis side, hydraulic traction motors
Parking brake	Spring-loaded, hydraulically ventilated disk brake
Traveling gear	900 mm triple bar shoes, maintenance-free tractor chassis 
Speed	0 – 2.5 kph
Options	900-mm flat crawler shoes

OPERATING WEIGHT	
Mass	Approx. 113,700 kg With 40.2-m telescopic boom, 8-m fly jib, 80 t hook, 900-mm triple-bar-shoes, 2 hoisting winches with hydraulically telescoping undercarriage, 33 t ballast
Note	Operating weight varies by model.

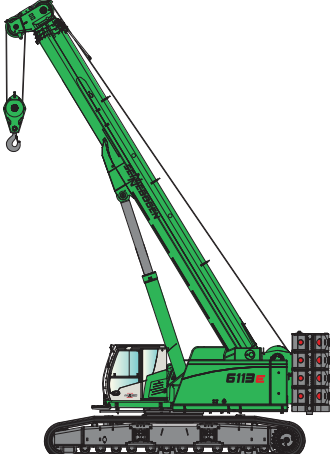

6113E Crane equipment



40.2-m main boom (HA)

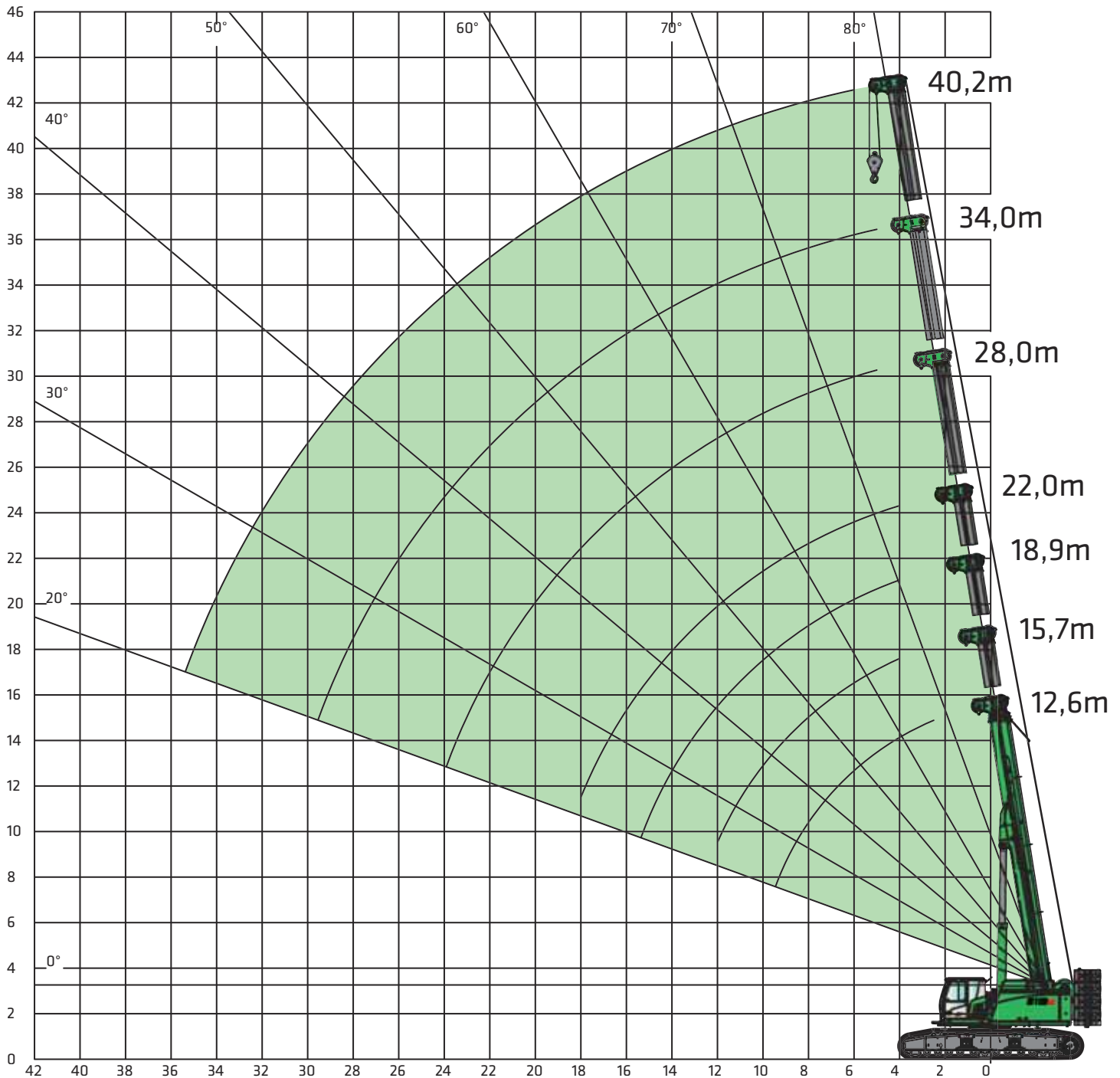

10 Subject to change. See page 21 for notes on load charts.

6113E Load ratings



0.2-m main boom (HA)

	Boom length [m]																				
	12.6			15.7			18.9			22.0			28.0			34.0			40.2		
Counterweight [t]																					
Carbody counterweight [t]																					
Undercarriage track width [m]																					
Working radius [m]																					
2.5	120.0																				
3.0	100.0																				
4.0	84.0	75.0	75.0	69.0	69.0	69.0	66.0	66.0	66.0	52.0	52.0	52.0									
5.0	75.0	75.0	75.0	69.0	69.0	69.0	61.4	61.4	61.4	52.0	52.0	52.0	37.0	37.0	37.0	30.0	30.0	30.0			
6.0	70.0	70.0	63.5	67.0	67.0	63.1	54.0	54.0	54.0	48.4	48.2	48.2	37.0	37.0	37.0	29.8	29.8	29.8	21.0	21.0	21.0
7.0	60.0	55.5	53.7	59.0	54.9	53.3	48.3	48.3	48.3	43.3	43.3	43.3	36.2	36.2	36.2	28.5	28.5	28.5	21.0	21.0	21.0
8.0	52.0	45.1	46.0	50.0	44.5	45.4	43.4	43.4	43.4	38.8	38.8	38.8	33.7	33.7	33.7	27.0	27.0	27.0	20.0	20.0	20.0
9.0	45.0	37.7	37.8	45.0	37.2	37.2	39.3	36.8	36.8	35.2	35.2	35.2	31.0	31.0	31.0	25.2	25.2	25.2	19.4	19.4	19.4
10.0	40.0	32.1	31.8	39.9	31.7	31.3	36.0	31.3	30.9	32.1	31.0	30.6	28.2	28.2	28.2	23.4	23.4	23.4	18.6	18.6	18.6
12.0				30.8	24.0	23.2	30.5	23.7	22.9	27.1	23.5	22.6	24.4	24.3	23.6	20.4	20.4	20.4	16.6	16.6	16.6
14.0							23.9	18.6	17.7	23.2	18.4	17.4	21.1	19.2	18.3	17.9	17.9	17.9	14.8	14.8	14.8
16.0							19.3	15.0	14.0	19.1	14.8	13.8	18.4	15.6	14.7	15.9	15.9	15.2	13.3	13.3	13.3
18.0										15.7	12.1	11.1	16.2	12.9	12.0	14.3	13.4	12.5	12.0	12.0	12.0
20.0													14.0	10.8	9.9	12.9	11.3	10.4	10.8	10.8	10.8
22.0													12.0	9.1	8.3	11.6	9.6	8.8	9.8	9.8	9.1
24.0													10.3	7.7	6.8	10.7	8.2	7.4	9.0	8.6	7.8
26.0																9.4	7.1	6.2	8.2	7.4	6.6
28.0																8.2	6.0	5.2	7.6	6.4	5.6
30.0																7.2	5.1	4.4	7.0	5.5	4.8
32.0																			6.4	4.7	4.0
34.0	Table no.: 6113R-75/2790/33.0+0.0/09.14 HA 0.3*																		5.7	4.0	3.3
36.0	Table no.: 6113R-75/2190/33.0+0.0/09.14 HA 0.3*																		5.1	3.4	2.8
Parts reeving	10	6	6	8	8	8	8	8	8	7	7	7	5	5	5	4	4	4	3	3	3
I	0%		33%			66%			100%			100%			100%						
II	0%		0%			0%			0%			33%			66%						
III	0%		0%			0%			0%			33%			66%						
Load ratings must be reduced when fly jib is mounted on basic body.																					
Reduction of load [kg]	520			420			350			300			240			200			170		

6113E Load ratings



Auxiliary jib (HA-S)

	Boom length [m]																				
	12.6			15.7			18.9			22.0			28.0			34.0			40.2		
Counterweight [t]	33.0	33.0	19.2	33.0	33.0	19.2	33.0	33.0	19.2	33.0	33.0	19.2	33.0	33.0	19.2	33.0	33.0	19.2	33.0	33.0	19.2
Carbody counterweight [t]	0.0	0.0	0.0	0.0	0.0	0.0	0.0	0.0	0.0	0.0	0.0	0.0	0.0	0.0	0.0	0.0	0.0	0.0	0.0	0.0	0.0
Undercarriage track width [m]	5.4	4.2	5.4	5.4	4.2	5.4	5.4	4.2	5.4	5.4	4.2	5.4	5.4	4.2	5.4	5.4	4.2	5.4	5.4	4.2	5.4
Working radius [m]																					
2.5																					
3.0	12.5	12.5	12.5	12.5	12.5	12.5															
4.0	12.5	12.5	12.5	12.5	12.5	12.5	12.5	12.5	12.5	12.5	12.5	12.5									
5.0	12.5	12.5	12.5	12.5	12.5	12.5	12.5	12.5	12.5	12.5	12.5	12.5	12.5	12.5	12.5	12.5	12.5	12.5			
6.0	12.5	12.5	12.5	12.5	12.5	12.5	12.5	12.5	12.5	12.5	12.5	12.5	12.5	12.5	12.5	12.3	12.3	12.3			11.9
7.0	12.5	12.5	12.5	12.5	12.5	12.5	12.5	12.5	12.5	12.5	12.5	12.5	12.5	12.5	12.5	12.2	12.2	12.2	11.8	11.8	11.8
8.0	12.5	12.5	12.5	12.5	12.5	12.5	12.5	12.5	12.5	12.5	12.5	12.5	12.5	12.5	12.5	12.1	12.1	12.1	11.7	11.7	11.7
9.0	12.5	12.5	12.5	12.5	12.5	12.5	12.5	12.5	12.5	12.5	12.5	12.5	12.4	12.4	12.4	12.0	12.0	12.0	11.5	11.5	11.5
10.0	12.5	12.5	12.5	12.5	12.5	12.5	12.5	12.5	12.5	12.5	12.5	12.5	12.3	12.3	12.3	11.9	11.9	11.9	11.4	11.4	11.4
12.0				12.5	12.5	12.5	12.5	12.5	12.5	12.5	12.5	12.5	12.3	12.3	12.3	11.8	11.8	11.8	11.3	11.3	11.3
14.0							12.5	12.5	12.5	12.5	12.5	12.5	12.3	12.3	12.3	11.8	11.8	11.8	11.1	11.1	11.1
16.0							12.5	12.5	12.5	12.5	12.5	12.5	12.3	12.3	12.3	11.7	11.7	11.7	10.8	10.8	10.8
18.0										12.5	12.4	11.5	12.3	12.3	12.2	11.7	11.7	11.7	10.3	10.3	10.3
20.0													12.3	11.0	10.1	11.5	11.5	10.6	9.5	9.5	9.5
22.0													12.1	9.3	8.4	10.6	9.8	8.9	8.7	8.7	8.7
24.0													10.4	7.9	7.0	9.8	8.4	7.6	8.0	8.0	7.9
26.0																9.0	7.2	6.4	7.4	7.4	6.7
28.0																8.3	6.1	5.3	6.9	6.5	5.7
30.0																7.2	5.2	4.4	6.4	5.6	4.8
32.0																			5.9	4.8	4.1
34.0	Table no.: 6113R-75/2790/33.0+0.0/09.14 HA-S 0.3°																		5.5	4.1	3.4
36.0	Table no.: 6113R-75/2190/33.0+0.0/09.14 HA-S 0.3°																		5.1	3.4	2.8
Parts reeving	1	1	1	1	1	1	1	1	1	1	1	1	1	1	1	1	1	1	1	1	1
I	0%			33%			66%			100%			100%			100%			100%		
II	0%			0%			0%			0%			33%			66%			100%		
III	0%			0%			0%			0%			33%			66%			100%		
Load ratings must be reduced when fly jib is mounted on basic body.																					
Reduction of load [kg]	770			610			510			430			340			280			240		

6113E Crane equipment



8-m or 15-m fly jib (SA)

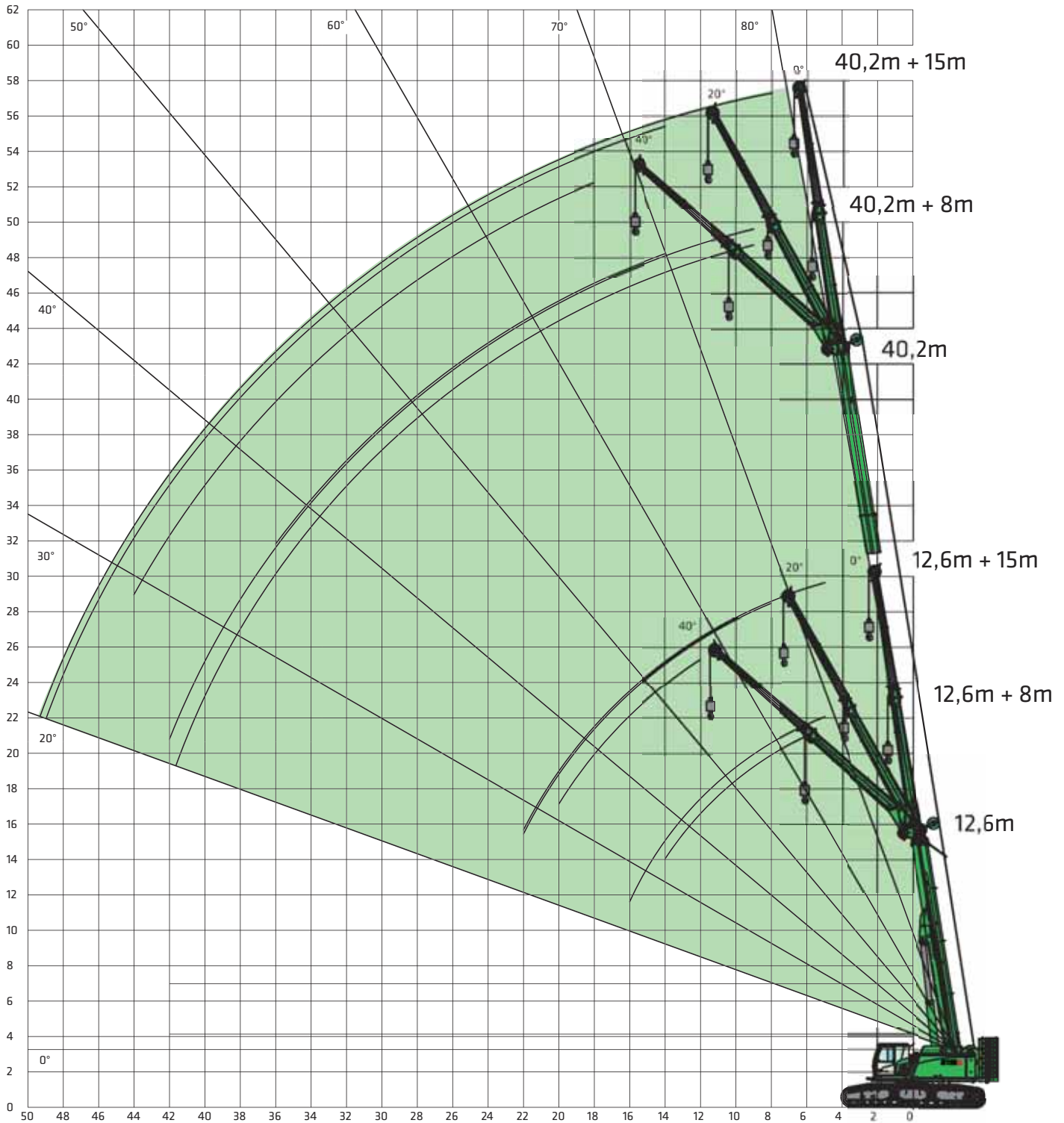

6113E Load ratings



8-m fly jib (SA)

33.0 t	0 t	Telescopic boom length [m]														
		12.6			22.0			28.0			34.2			40.2		
5.4 m	0°	20°	40°	0°	20°	40°	0°	20°	40°	0°	20°	40°	0°	20°	40°	
Working radius [m]																
5.0	15.4	10.9		18.0			17.5									
6.0	14.0	10.2	8.1	16.5			16.5									
7.0	12.8	9.7	7.8	15.5	10.5		15.6	10.3		14.2						
8.0	11.8	9.2	7.5	14.5	10.1	7.8	14.7	10.1		13.7						
9.0	10.9	8.7	7.2	13.6	9.7	7.6	14.0	9.8	7.6	13.1	9.5		11.8			
10.0	10.2	8.3	6.9	12.8	9.3	7.4	13.3	9.5	7.4	12.6	9.3	7.3	11.4			
12.0	9.0	7.5	6.4	11.5	8.7	7.0	12.1	8.9	7.1	11.7	8.8	7.0	10.8	8.4		
14.0	8.0	7.1	6.1	10.4	8.2	6.6	11.0	8.4	6.7	10.9	8.3	6.7	10.2	8.0	6.5	
16.0	7.2	6.7		9.5	7.7	6.3	10.2	8.0	6.5	10.2	8.0	6.4	9.6	7.7	6.3	
18.0				8.7	7.3	6.1	9.5	7.6	6.3	9.5	7.6	6.2	9.1	7.4	6.1	
20.0				8.1	7.0	5.9	8.8	7.3	6.0	9.0	7.3	6.0	8.5	7.1	5.9	
22.0				7.5	6.7		8.2	7.0	5.8	8.4	7.0	5.8	8.0	6.9	5.8	
24.0				7.0	6.5		7.7	6.7	5.7	8.0	6.8	5.7	7.4	6.6	5.6	
26.0							7.3	6.5	5.6	7.5	6.6	5.5	6.8	6.4	5.5	
28.0							6.9	6.4		7.2	6.4	5.4	6.3	6.2	5.3	
30.0							6.6	6.2		6.8	6.2	5.3	5.8	5.8	5.2	
32.0							6.4			6.5	6.1		5.4	5.5	5.2	
34.0										5.9	6.0		5.0	5.1	5.1	
36.0										5.2	5.4		4.7	4.7	4.8	
38.0										4.6			4.3	4.4		
40.0													4.0	4.1		
42.0													3.6	3.7		
44.0													3.2			
46.0																
48.0																
50.0																
52.0																
54.0	Table no.: 6113R-75/2790/33.0+0.0/09.14 SA8 0.3*															
Parts reeving	2	2	1	2	2	1	2	2	1	2	2	1	2	2	1	
I	0%			100%			100%			100%			100%			
II	0%			0%			33%			66%			100%			
III	0%			0%			33%			66%			100%			

6113E Load ratings



15 m fly jib (SA)

33.0 t	0 t	Telescopic boom length [m]														
		12.6			22.0			28.0			34.2			40.2		
5.4 m	0°	20°	40°	0°	20°	40°	0°	20°	40°	0°	20°	40°	0°	20°	40°	
Working radius [m]																
5.0	6.0			6.0												
6.0	5.8			5.8			5.8			5.3						
7.0	5.6			5.7			5.6			5.2						
8.0	5.4			5.6			5.4			5.1			4.7			
9.0	5.1	4.1		5.5			5.3			5.0			4.7			
10.0	4.8	4.0		5.3	4.0		5.2			4.9			4.6			
12.0	4.4	3.6	3.1	5.0	3.9		5.0	4.0		4.8			4.5			
14.0	4.0	3.4	2.9	4.7	3.7	3.1	4.8	3.8	3.1	4.6	3.8		4.3			
16.0	3.6	3.2	2.8	4.3	3.5	3.0	4.6	3.6	3.0	4.4	3.6	3.0	4.2	3.5		
18.0	3.3	3.0	2.7	4.0	3.3	2.9	4.3	3.4	2.9	4.3	3.4	2.9	4.1	3.4	2.8	
20.0	3.1	2.8	2.6	3.7	3.2	2.8	4.0	3.3	2.8	4.1	3.3	2.8	4.0	3.2	2.7	
22.0	2.9	2.7		3.5	3.0	2.7	3.8	3.1	2.7	3.9	3.2	2.7	3.8	3.1	2.6	
24.0				3.3	2.9	2.6	3.6	3.0	2.7	3.7	3.1	2.7	3.7	3.0	2.5	
26.0				3.1	2.8	2.6	3.4	2.9	2.6	3.5	2.9	2.6	3.5	2.9	2.5	
28.0				2.9	2.7	2.5	3.2	2.8	2.5	3.3	2.9	2.5	3.4	2.8	2.5	
30.0				2.8	2.6		3.1	2.7	2.5	3.2	2.8	2.5	3.2	2.7	2.5	
32.0							2.9	2.7	2.4	3.1	2.7	2.4	3.1	2.7	2.4	
34.0							2.8	2.6		2.9	2.6	2.4	3.0	2.6	2.4	
36.0							2.7	2.6		2.8	2.6	2.4	2.9	2.6	2.3	
38.0							2.6	2.5		2.7	2.5	2.3	2.8	2.5	2.3	
40.0										2.6	2.5		2.7	2.5	2.3	
42.0										2.5	2.5		2.6	2.4	2.2	
44.0													2.5	2.4	2.2	
46.0													2.4	2.4		
48.0													2.4	2.4		
50.0													2.4	2.4		
52.0																
54.0	Table no.: 6113R-75/2790/33.0+0.0/09.14 SA15 0.3*															
Parts reeving	2	2	1	2	2	1	2	2	1	2	2	1	2	2	1	
I	0%			100%			100%			100%			100%			
II	0%			0%			33%			66%			100%			
III	0%			0%			33%			66%			100%			

6113E Crane equipment



Main boom with 12-m main boom extension (HAV)

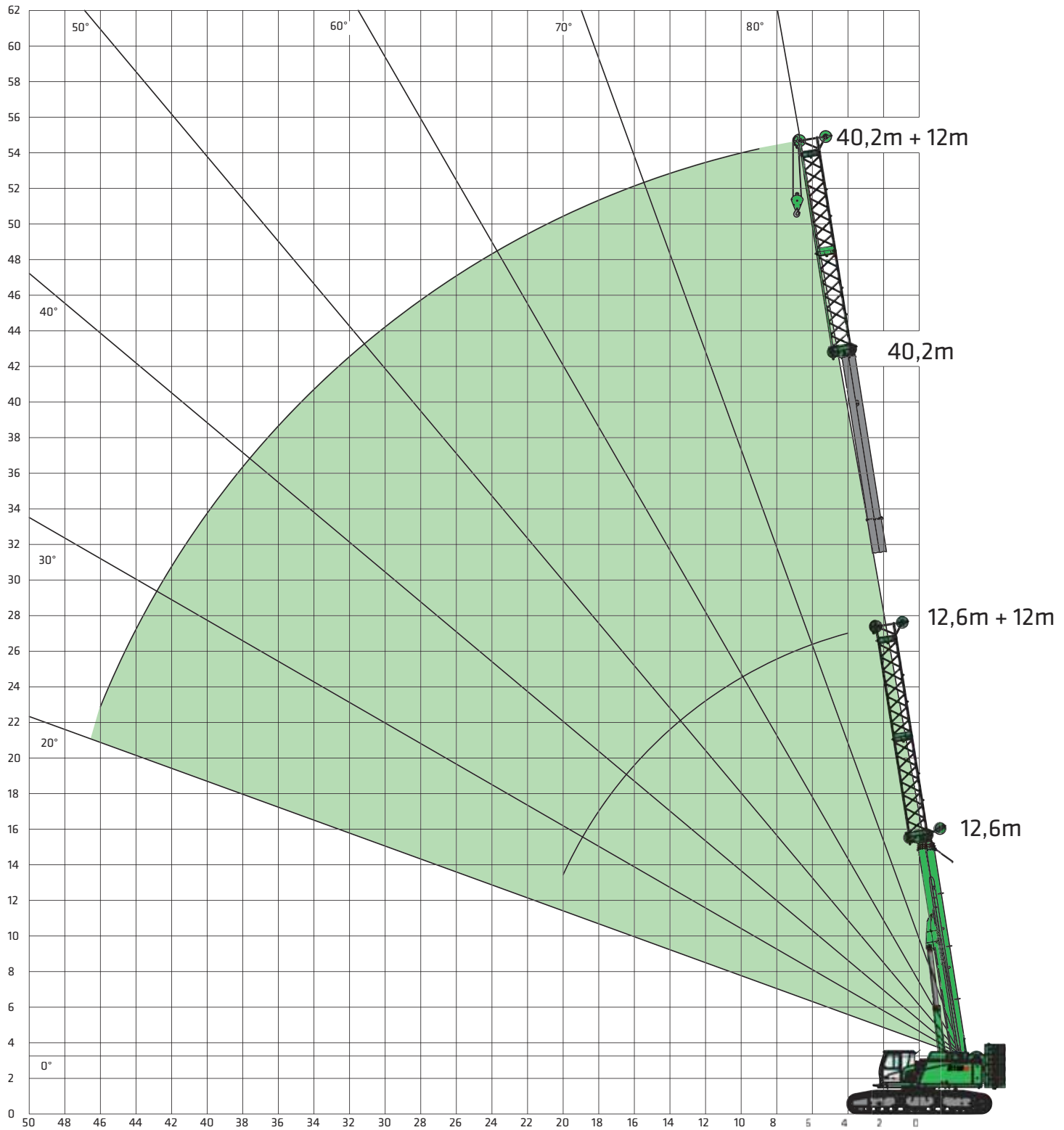

6113E Load ratings



Main boom with 12-m main boom extension (HAV)

33.0 t		0 t		Boom length [m]	
5.4 m					
Working radius [m]	24.6	34.0	40.0	46.2	52.2
4.0	18.7	19.7			
5.0	16.9	18.3			
6.0	15.3	17.0	16.3		
7.0	14.0	15.7	15.4	13.7	
8.0	12.9	14.8	14.6	13.2	
9.0	12.0	13.9	13.7	12.7	11.1
10.0	11.1	13.0	13.1	12.2	10.8
12.0	9.8	11.7	11.9	11.3	10.2
14.0	8.7	10.6	11.0	10.5	9.6
16.0	7.8	9.6	10.1	9.8	9.1
18.0	7.1	8.9	9.4	9.3	8.5
20.0	6.5	8.2	8.7	8.7	7.9
22.0		7.6	8.1	8.2	7.3
24.0		7.1	7.6	7.8	6.7
26.0		6.6	7.2	7.4	6.2
28.0		6.3	6.8	6.8	5.7
30.0			6.5	6.3	5.3
32.0			6.2	5.8	4.9
34.0			5.9	5.4	4.5
36.0				5.0	4.2
38.0				4.7	3.9
40.0				4.2	3.6
42.0					3.3
44.0					3.0
46.0	Table no.: 6113R-75/2790/33.0+0.0/09.14 HAV12				2.8
Parts reeving	2	2	2	2	2
I	0%	100%	100%	100%	100%
II	0%	0%	33%	66%	100%
III	0%	0%	33%	66%	100%
Load ratings must be reduced when fly jib is mounted on basic body.					
Reduction of load [kg]	520	300	240	200	170

6113E Crane equipment



15-m fly jib (SA) with 12-m-main boom extension (HAV)

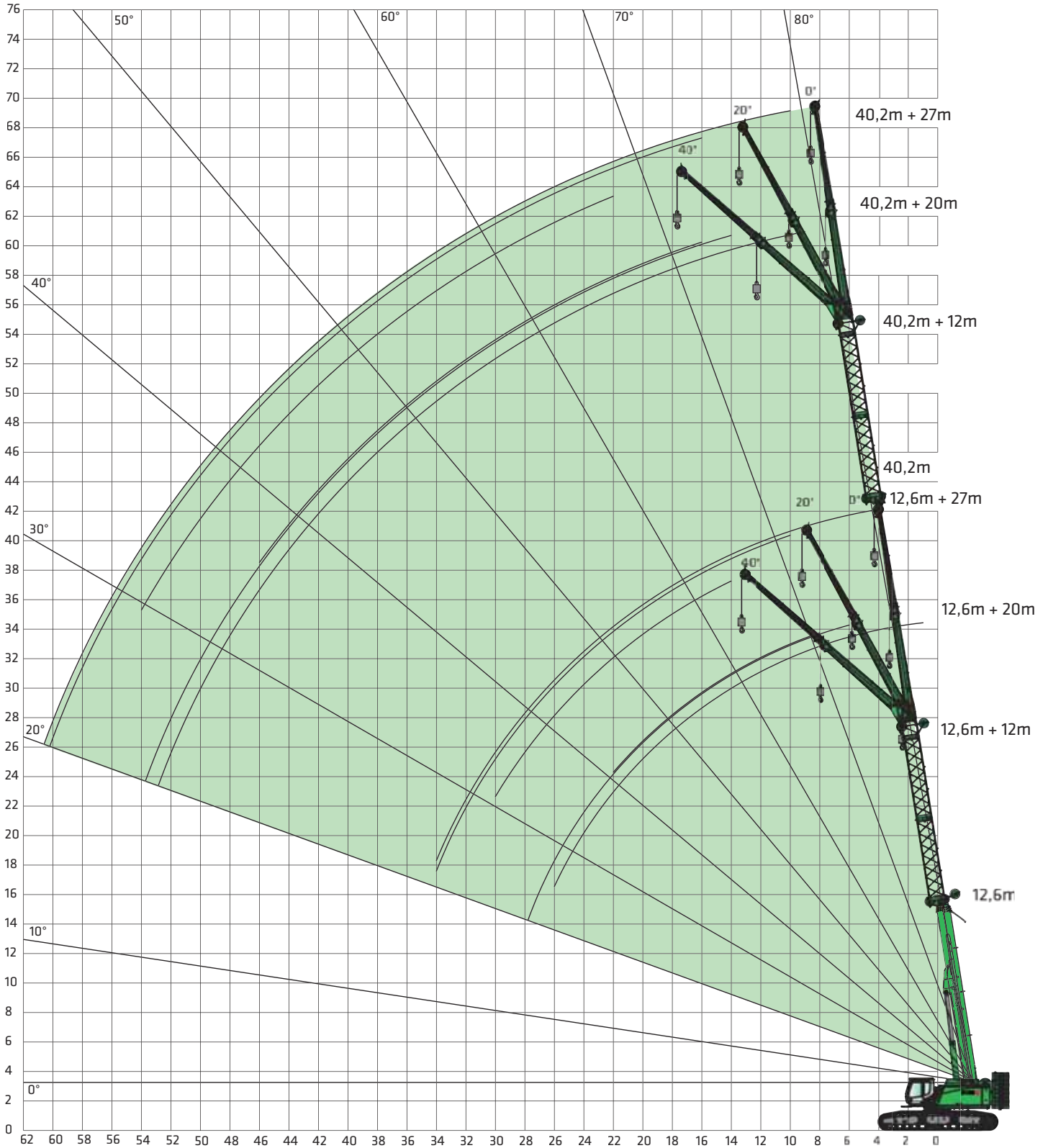

18 Subject to change. See page 21 for notes on load charts.

6113E Load ratings











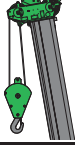
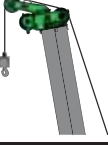































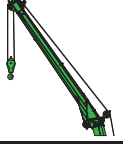











15-m fly jib (SA) with 12-m-main boom extension (HAV)

33.0 t	0 t	Telescopic boom length [m]														
		12.6			22.0			28.0			34.2			40.2		
5.4 m	12 + 15			12 + 15			12 + 15			12 + 15			12 + 15			
	0°	20°	40°	0°	20°	40°	0°	20°	40°	0°	20°	40°	0°	20°	40°	
Working radius [m]																
4.0	5.0															
5.0	5.0															
6.0	5.0			4.5												
7.0	5.0			4.5			4.3									
8.0	5.0			4.5			4.3									
9.0	5.0			4.5			4.3			3.8						
10.0	4.9	3.2		4.5			4.3			3.8			2.5			
12.0	4.7	3.2		4.5	3.1		4.3			3.8			2.5			
14.0	4.5	3.2	2.6	4.5	3.1		4.2	3.0		3.8	2.9		2.5			
16.0	4.3	3.2	2.6	4.3	3.1	2.5	4.1	3.0		3.8	2.9		2.5	2.5		
18.0	4.0	3.2	2.6	4.2	3.1	2.5	4.0	3.0	2.5	3.7	2.9		2.5	2.5		
20.0	3.6	3.0	2.6	4.0	3.1	2.5	3.9	3.0	2.5	3.6	2.9	2.6	2.5	2.5		
22.0	3.3	2.9	2.6	3.8	3.1	2.5	3.7	3.0	2.5	3.5	2.9	2.5	2.5	2.5	2.4	
24.0	3.1	2.8	2.5	3.6	3.0	2.5	3.6	3.0	2.5	3.4	2.9	2.4	2.5	2.5	2.3	
26.0	2.8	2.6	2.4	3.3	2.8	2.5	3.4	2.9	2.5	3.3	2.8	2.4	2.5	2.5	2.3	
28.0	2.6	2.4	2.4	3.1	2.7	2.4	3.2	2.8	2.4	3.1	2.8	2.4	2.5	2.5	2.3	
30.0	2.4	2.3	2.3	2.9	2.6	2.4	3.0	2.7	2.3	3.0	2.7	2.3	2.5	2.5	2.2	
32.0	2.2	2.1		2.7	2.5	2.3	2.8	2.6	2.3	2.9	2.6	2.3	2.5	2.5	2.2	
34.0	2.1	2.0		2.6	2.3	2.3	2.6	2.5	2.3	2.7	2.5	2.2	2.5	2.5	2.1	
36.0				2.4	2.2	2.2	2.5	2.4	2.3	2.6	2.4	2.2	2.5	2.4	2.1	
38.0				2.3	2.1	2.1	2.4	2.2	2.2	2.5	2.3	2.1	2.5	2.3	2.1	
40.0				2.1	2.0		2.2	2.1	2.1	2.3	2.2	2.1	2.4	2.3	2.1	
42.0				2.0	1.9		2.1	2.0	2.0	2.2	2.1	2.1	2.3	2.2	2.0	
44.0					1.8		2.0	2.0		2.1	2.0	2.0	2.2	2.1	2.0	
46.0							1.9	1.9		2.0	2.0	2.0	2.1	2.0	2.0	
48.0							1.8	1.8		1.9	1.9	1.9	2.0	2.0	2.0	
50.0								1.7		1.9	1.8		1.8	1.9	1.9	
52.0										1.8	1.8		1.7	1.8	1.8	
54.0										1.7	1.7		1.5	1.6	1.7	
56.0											1.7		1.4	1.5		
58.0													1.2	1.3		
60.0													1.1	1.2		
62.0													0.9	1.0		
64.0	Table no.: 6113R-75/2790/33.0+0.0/09.14 HAV12 + SA15															
Parts reeving	2	2	2	2	2	2	2	2	2	2	2	2	2	2	2	
I	0%			100%			100%			100%			100%			
II	0%			0%			33%			66%			100%			
III	0%			0%			33%			66%			100%			



6113E Load capacity programs

	Main boom (HA)			Auxiliary jib (HA-S)			12-m main boom extension (HAV)		
									
Undercarriage track width	 5.4 m	 4.2 m	 3.05 m	 5.4 m	 4.2 m	 3.05 m	 5.4 m	 4.2 m	 3.05 m
Counterweight [t]									
 33 t	360° 	360° 	-	360° 	360° 	-	360° 	-	-
 19.2 t	360° 	360° 	360° 	360° 	360° 	360° 	-	-	-
 0 t	360° 	360° 	360° 	360° 	360° 	360° 	-	-	-

	8-m fly jib (SA)			15-m fly jib (SA)			12-m main boom extension (HAV) + 8-m fly jib (SA)			12-m main boom extension (HAV) + 15-m fly jib (SA)		
												
Undercarriage track width	 5.4 m	 4.2 m	 3.05 m	 5.4 m	 4.2 m	 3.05 m	 5.4 m	 4.2 m	 3.05 m	 5.4 m	 4.2 m	 3.05 m
Counterweight [t]												
 33 t	360° 	-	-	360° 	-	-	360° 	-	-	360° 	-	-
 19.2 t	-	-	-	-	-	-	-	-	-	-	-	-
 0 t	-	-	-	-	-	-	-	-	-	-	-	-

Note:

1. Specified load ratings only apply when machine is level ($\pm 0.3^\circ$) and stable.
2. Load ratings are in tons (t) and apply for 360 degrees.
3. Load ratings are in accordance with EN 13000.
4. The weight of the load handling devices (e.g., hook, cable) must be subtracted from the load ratings.
5. Load ratings must be limited or reduced when conditions are unfavorable, such as soft or uneven ground, slopes, wind, lateral loads, swinging loads, jerking or sudden stopping of load, operator inexperience, driving with load.
6. Permissible cable pull per strand in crane mode for cable diameter 26 mm - 12,500 kg.
7. Specified load ratings are for reference only. See the tables in the operating manual for the applicable load rating.
8. Optional lift capacities available for 2° and 4° incline positions.

6113E Transport dimensions and weights

Weight: approx. 113.7 t (2 winches, 8 m fly jib, 80 t hook, 33 t counterweight, 900 mm 3-grouser crawler shoes)
 Transport width: 4 m

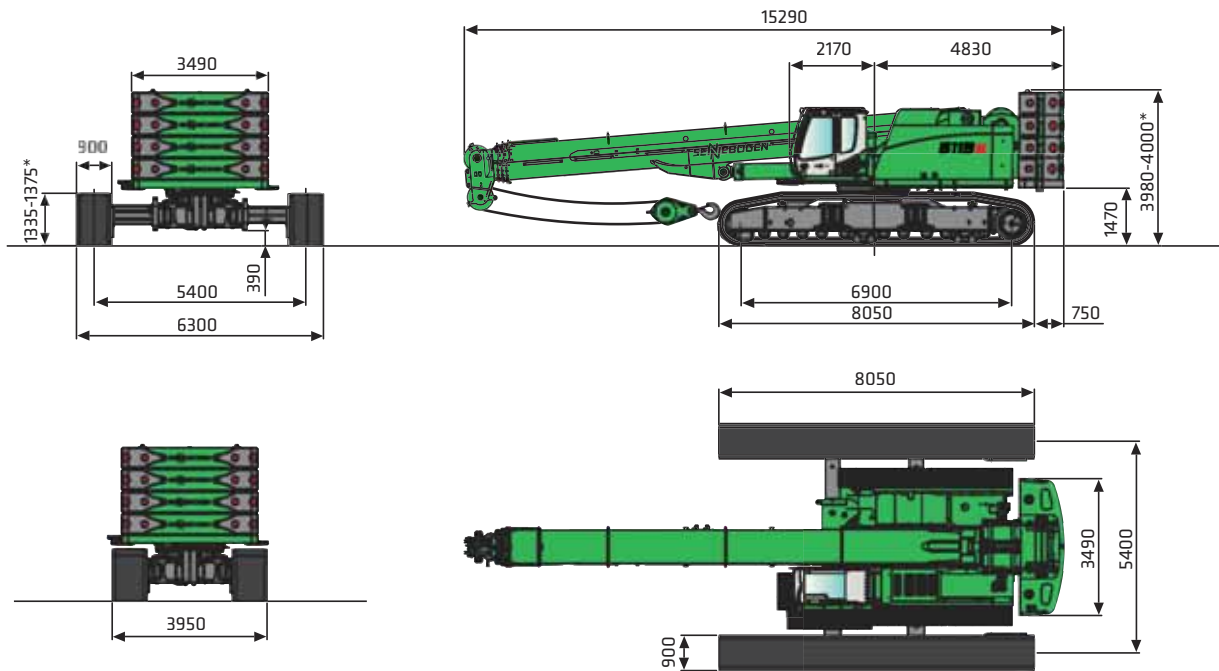

Weight: approx. 79.7 t (2 winches, 8 m fly jib, 80 t hook, no counterweight, 900-mm triple-bar-shoes)
 Transport width: 4 m

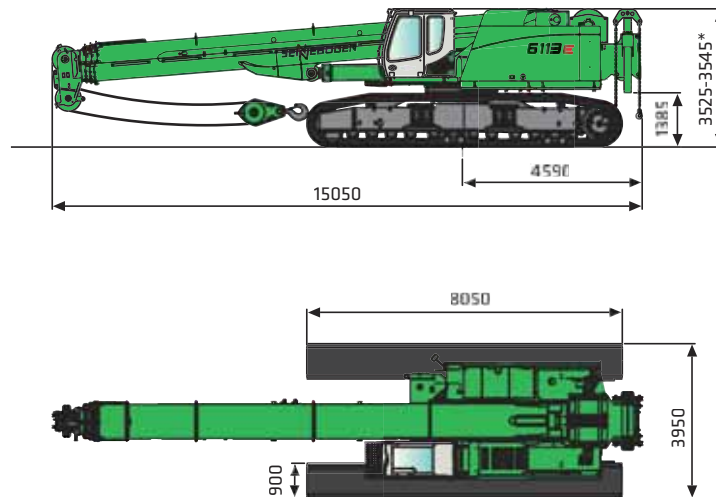

Weight: approx. 47.7 t (2 winches, 8 m fly jib, 80 t hook)
 Transport width: 3 m

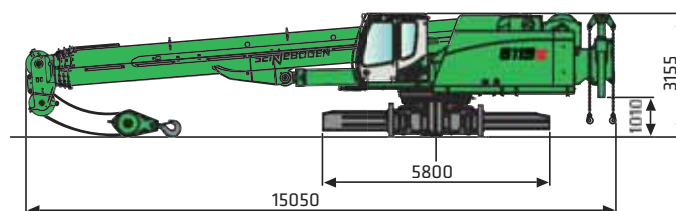

6113E Transport dimensions and weights

	<p>Track wheel carrier (triple grouser plates) 2 x Track wheel carrier (flat bottom plates) 2 x</p>	<p>16,000 kg 17,400 kg</p>
	<p>Base plate for counterweight</p>	<p>1x 5,400 kg</p>
	<p>Counterweight</p>	<p>4x 6,980 kg</p>
	<p>8 m fly jib</p>	<p>900 kg</p>
	<p>7 m fly jib extension</p>	<p>300 kg</p>
	<p>Auxiliary jib</p>	<p>160 kg</p>
	<p>Boom section</p>	<p>573 kg</p>
	<p>Boom head</p>	<p>391 kg</p>

6113E Self-assembly system

1

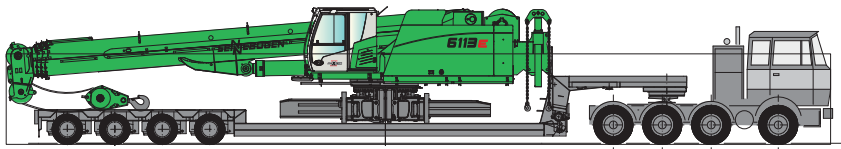

2

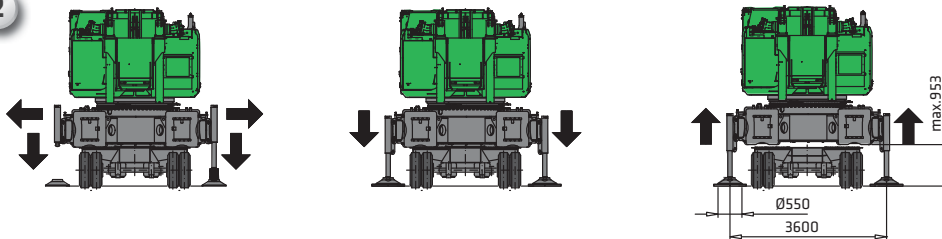

3

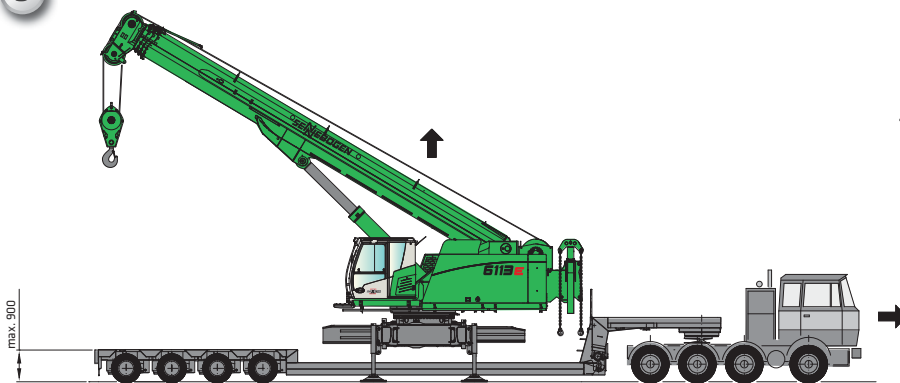

4

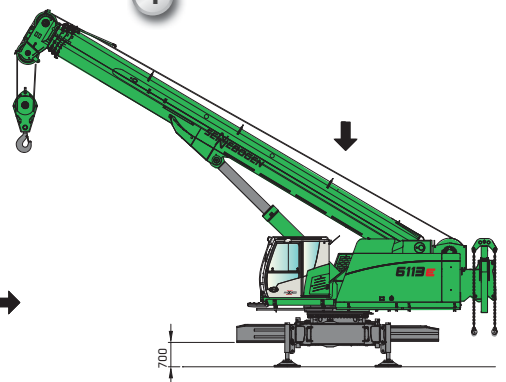

5

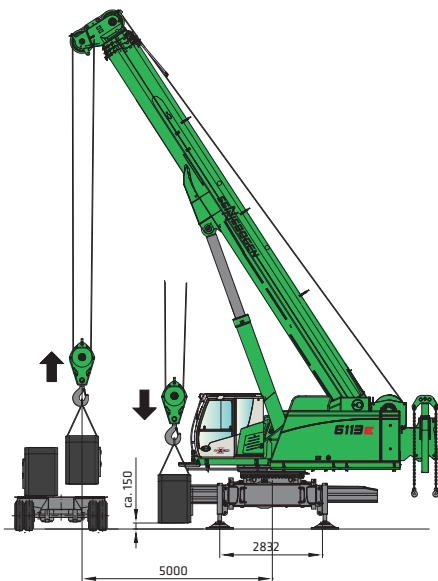

6

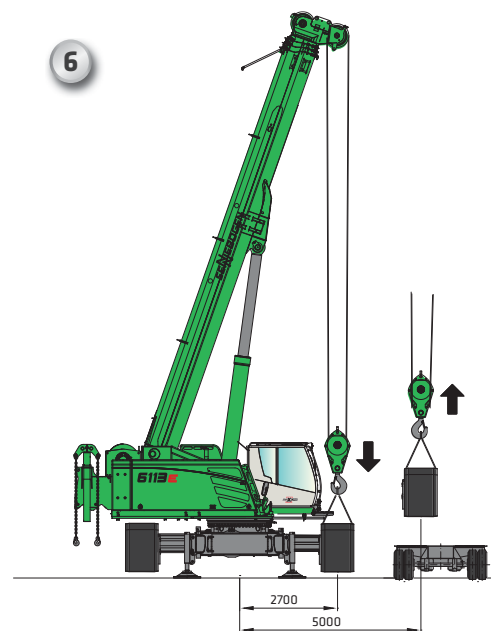

6113E Self-assembly system

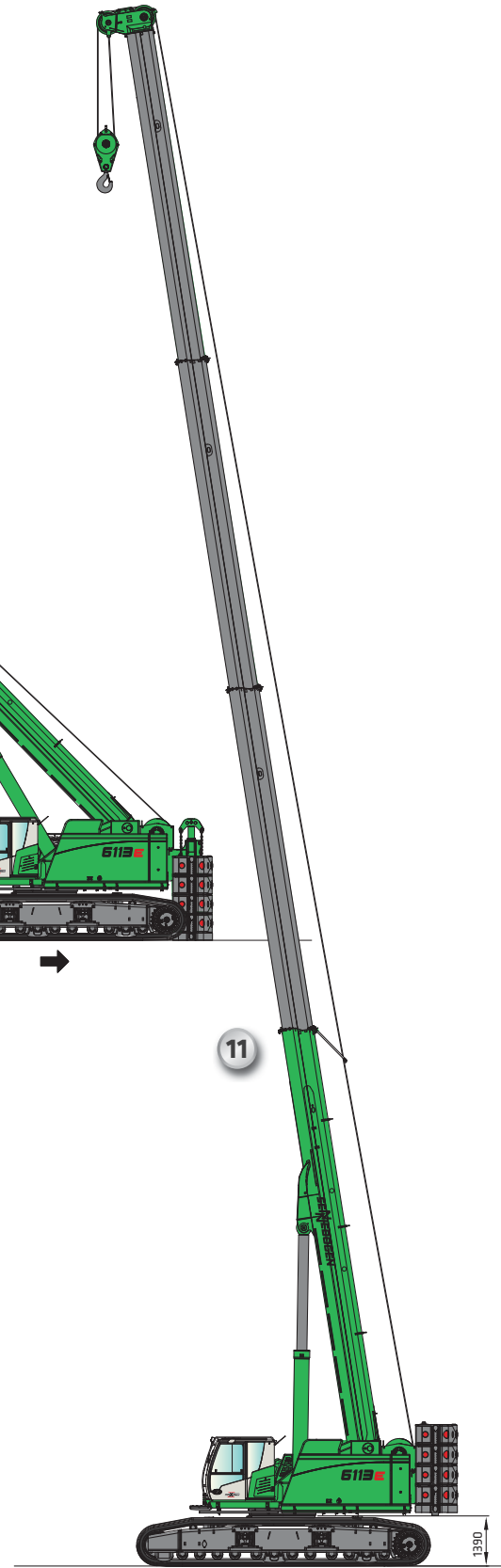
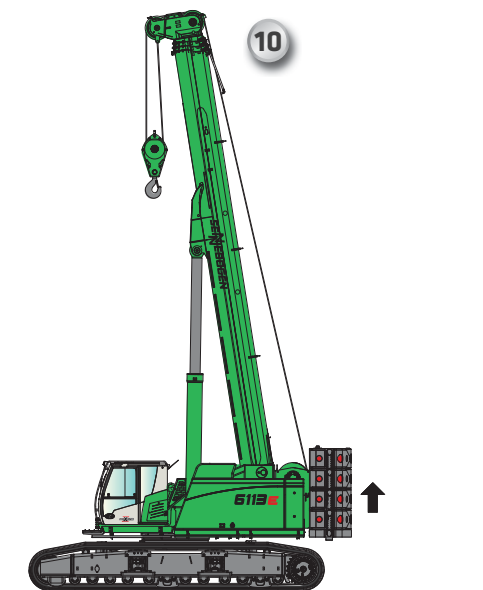
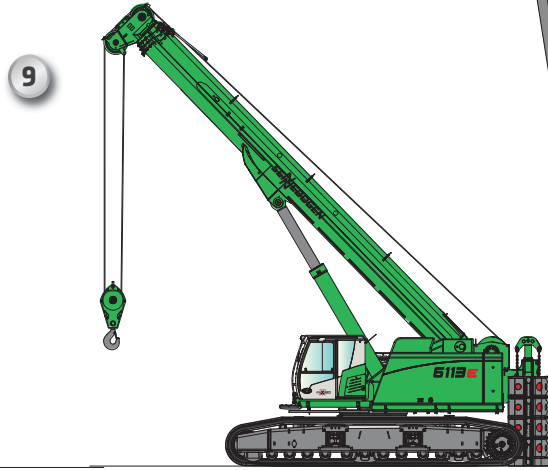
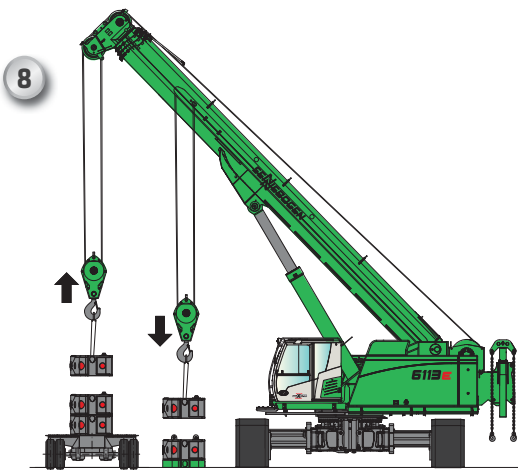
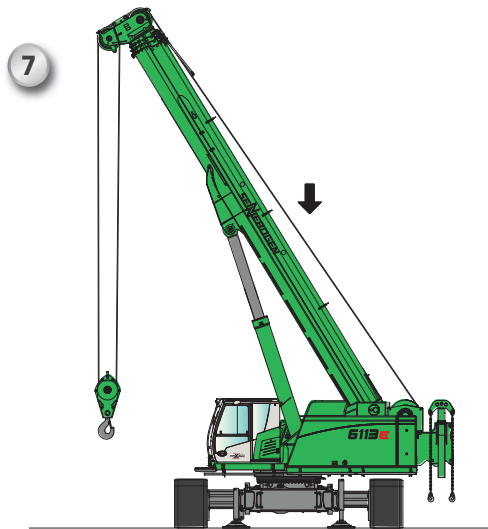



6113 R - high stability on any site surface with Star-Lifter broad gauge chassis; Germany



26 6113 R - moving and positioning large and heavy components in civil engineering; Germany



6113 R - Lifting and handling of heavy concrete parts; Singapore

6113E

R

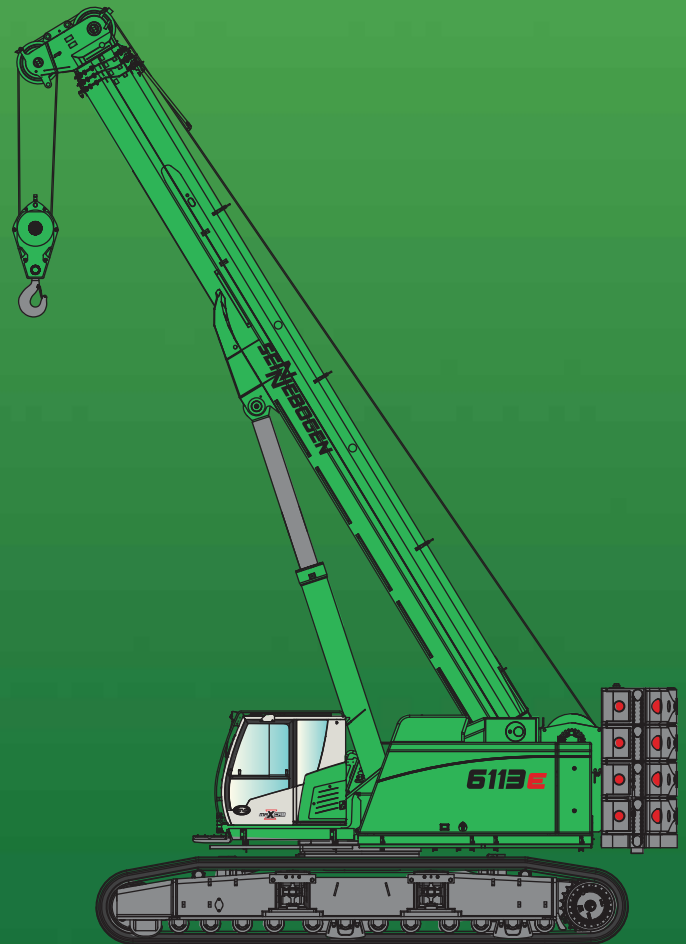

This catalog describes machine models, scopes of equipment of individual models, and configuration options (standard equipment and optional equipment) of the machines delivered by SENNEBOGEN Maschinenfabrik. Machine illustrations can contain optional equipment and supplemental equipment. Actual equipment may vary in a tolerance range depending on the country to which the machines are delivered, especially in regard to standard and optional equipment

All product designations used may be trademarks of SENNEBOGEN Maschinenfabrik GmbH or other supplying companies, and any use by third parties for their own purposes may violate the rights of the owners.

Please contact your local SENNEBOGEN sales partner for information concerning the equipment variants offered. Requested performance characteristics are only binding if they are expressly stipulated upon conclusion of the contract. Delivery options and technical features are subject to change. Errors and omissions excepted. Equipment is subject to change, and rights of advancement are reserved.

© SENNEBOGEN Maschinenfabrik GmbH, Straubing/Germany. Reproduction in whole or in part only with written consent of SENNEBOGEN Maschinenfabrik GmbH, Straubing, Germany.

The Sennebogen logo, consisting of the word 'SENNEBOGEN' in a stylized, bold, sans-serif font. The letters are white with a black outline and are set against a green background.

SENNEBOGEN
Maschinenfabrik GmbH
Sennebogenstrasse 10
94315 Straubing, Germany

Tel. +49 9421 540-144/146
marketing@sennebogen.de

Order no. / Item no. 187001
6113-E-041510-091610-011910-11219d

GO FOR GREEN

www.sennebogen.com